

créo

Designed in Italy, Manufactured in the USA



We are very proud to introduce Creo, an innovative Visual Merchandising Exhibit System featuring:

- Tool Free Assembly
Set-up designed to be intuitive, simple and fast.
- Clean Sleek Design
Award winning contemporary look.
- Easy Graphics Integration
Create brand and message awareness.
- Modular Construction
Easily reconfigured to facilitate design changes.

Designed and engineered in Italy, Manufactured in the USA.

Creo can be customized and interpreted in an infinite number of ways. Design systems best suited to your client's requirements.

Whether for point-of-sale, trade show expositions or other mobile marketing opportunities, Creo is excellent.

Creo's value proposition is compelling.



International Patent Pending No. PCT/1B2007/000846 Registered Design No. PD2007O000048

About this Catalog

- Possible CREO configurations are endless. All components have a list price and we offer deep discounts to qualified resellers. Catalog assemblies show a reference number, for which our sales staff can offer wholesale pricing as of June 2012.
- Creative Design - view catalog as an idea book. Together, we can design custom products to meet specific needs. Engineered prototypes can ensure stability and functionality before production runs.

Innovative Design, Tool-Free

... a compelling value proposition.

Index

The System		Application		P.O.S. Concepts		Tradeshow		Structures	
Uprights & Cone Tops	6	Garment Hanging	22-23	Single Upright Concepts	42-47	10' x 10' Exhibit Booths	54-57	Assorted Structures	66-67
Bases	7	Perimeter Spanning	24-25	Double Upright Concepts	48-49	10' x 20' Exhibit Booths	58-61		
Crossbars	8-9	Slatwall & Pegboard	26-27	Larger Examples	50-53	10' x 30' Exhibit Booths	62-63		
Graphic Supports	10-11	Video	28-29			Larger Exhibit Booths	64-65		
Aluminum Frames	12-13	Kiosks	30-31						
Shelving	14-15	Towers	32-33						
Cafe Shelves, Trays	16-17	Crowd Control	34-35						
Brackets, Connectors	18-21	Podiums	36-39						
Accessories, & Cases		Demo Tables	40-41						

Uprights and Tops

Uprights

Assembly is fast, intuitive, and Tool-Free!

Etched & Clear Satin Anodized Finish

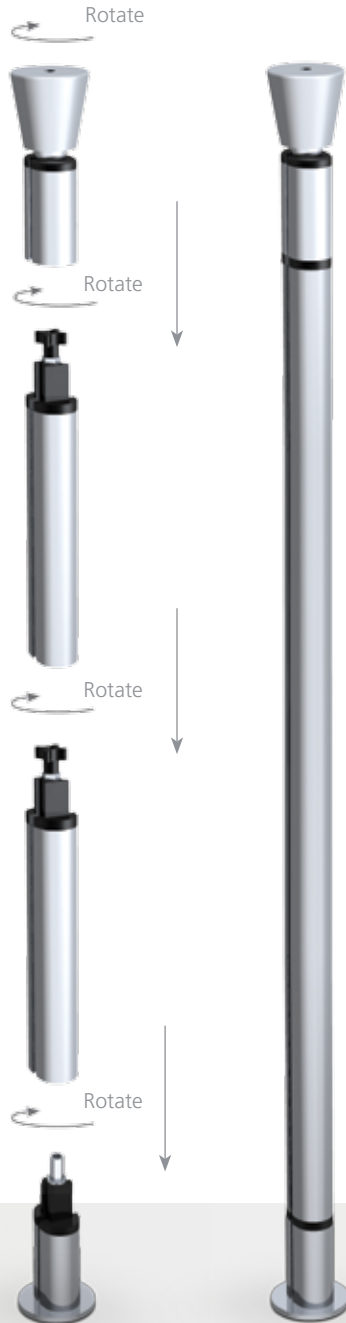
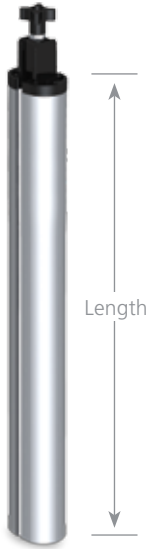

Model	Length
CRP72	60-3/4"
CRP84	72-3/4"
CRP96	84-3/4"
CRP12	12-3/8"
CRP18	17-5/8"
CRP36	30-3/8"
CRP42	36-3/8"
CRP48	42-3/8"

Cone Tops



Black -B



Silver -S



Red -R



White -W

Stylish and functional, Cone Tops screw onto upright tops.

CRCT: -B, -S, -R, -W

All tops are 7' high
 All Bases are 4-1/4' high



Simple Tops

CRCLOS Plain Top is a simple closure.

CRKT Knob Top screws onto upright securely.



2 minute assembly without tools!

Steel Bases

Laser cut 1/4" steel, satin silver powder coated.

TOOL FREE ASSEMBLY
ITALIAN DESIGN
MORE SPECIALITY BASES PAGE 16.

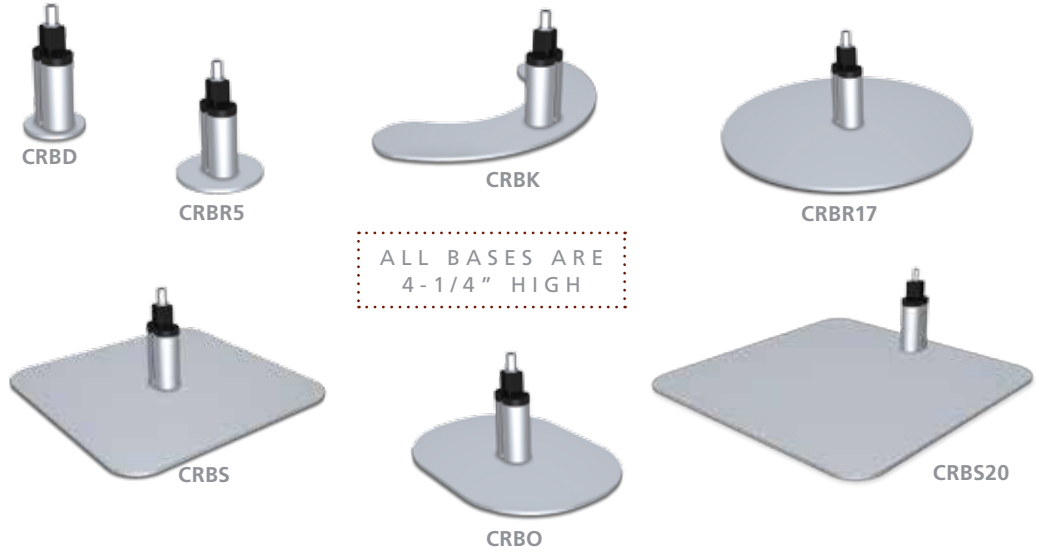

ALL BASES ARE
4-1/4" HIGH

Steel Bases Specify Color: -B, -S, -R, -W (same cost).

CRBD	3-1/4" Round Disc, 1-1/2 lbs.
CRBR5	5" Round, 2 lbs.
CRBS	16" Square, 18 lbs.

CRBR17	17" Round, 16 lbs.
CRBO	10" x 14" Oval, 7 lbs.
CRBK	4" x 17" Kidney, 5-1/2 lbs.

CRBS20	20" Square, 28 lbs.
---------------	---------------------

Offset mount for heavy applications

Aluminum Bases

Satin anodized finish



CRBP	Tripod
-------------	--------

CRBT	24" Aluminum "T"
-------------	------------------

CRBF	24" Off Center Aluminum "T"
-------------	-----------------------------



Crossbars

Aluminum Crossbars

- Lightweight, strong aluminum alloy
- Satin anodized finish
- Reliable tool-free connection
- Positionable wherever upright sections meet

Standard Straight Crossbars

Straight crossbars require side by side parallel uprights. Our full range of accessories including shelves can be used.



Straight Crossbar

Pivoting Crossbar

Pivoting Crossbars

Economical for towers and other multi-directional structures, but accessory options are limited.



Retractable Graphic Crossbar Set

Simply pull down to use. Graphic attaches with included hook/loop. Pocket arm is provided for a bottom hem, fully adjustable.



Graphics store securely & conveniently inside case.

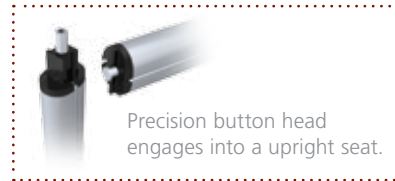

Precision button head engages into a upright seat.

Rotated Crossbars

Rotated 90° so tracks face up and down, allow special assembly installations.



Width	Standard Straight	Pivoting	Retractable	Rotated 90°
24"	CRCB2	CRAPB2	CRPC2	CR9CB2
30"	CRCB25	CRAPB25	N/A	CR9CB25
36"	CRCB3	CRAPB3	CRPC3	CR9CB3
48"	CRCB4	CRAPB4	CRPC4	CR9CB4
60"	CRCB5	CRAPB5	CRPC5	CR9CB5
60"	CRCB52S*	CRAPB52S*	N/A	N/A

* 2 section crossbars so can fit cases.



Pivoting Crossbars have limited accessory options.

Standard Crossbars allow for use of all accessories.



Retractable Crossbar houses graphic.

Rotated Crossbars have slots facing up & down.

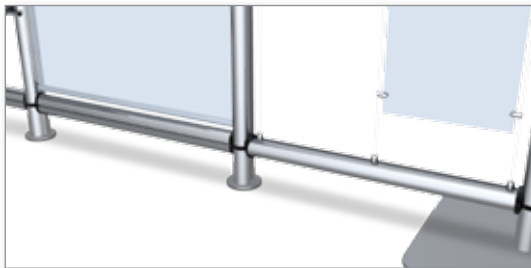

Retractable has pole pocket bottom. Standard crossbar below.

Rotated Crossbar with up facing slot.

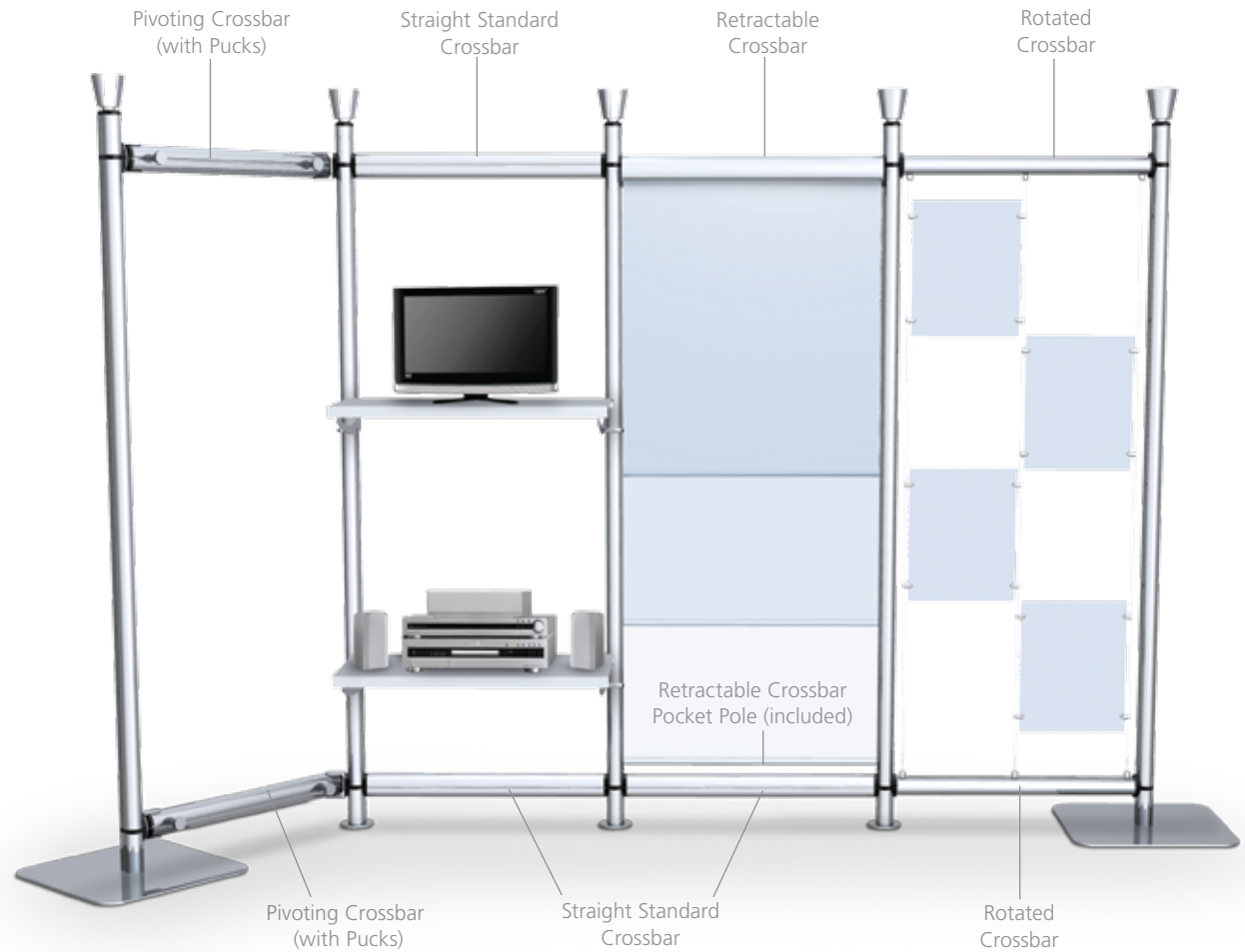

ALL CROSSBARS CONNECT TOOL-FREE.

Crossbars can be positioned wherever upright sections meet. Steel Button heads seat firmly into close tolerance slots.

Graphic Supports

Pocket Arms

2 pole set, 3/4" diameter includes moveable glides.
Hem graphics top and bottom to mount.



CRPA-2	24"
CRPA-25	30"
CRPA-3	36"
CRPA-4	48"
CRPA-5	60"
CRPA-5ST	60"*

*Made in two sections.

Graphic Rods

Sleek, 5/8" diameter tubes tighten anywhere along track.
Includes aluminum face-out puck. For hemmed graphics. 2/set.



CRGR-1	18"
CRGR-2	24"

Panel Grippers

Frameless graphic attachment of rigid substrates.

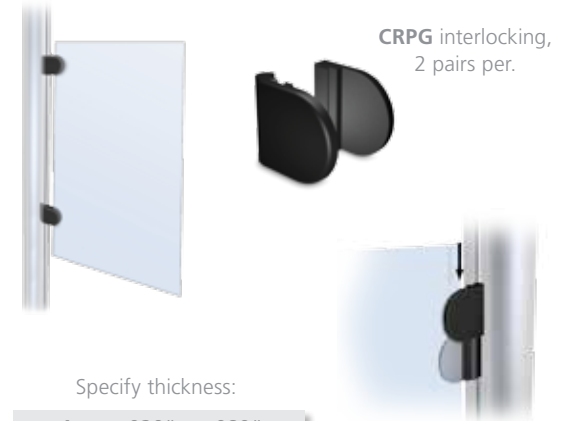

CRPG interlocking,
2 pairs per.

Specify thickness:

-1	.020" - .080"
-2	.120" - .187"
-3	.187" - .250"

First part snaps in then
slide together with
graphic between.

Aluminum Clamps

Beautiful satin anodized, rubber lined jaws,
strong binder spring, connector included.



CRVM1
Mounts on side
faces front.

CRVM2
Mounts and
faces to side.

Two **CRVM1**'s

Angle Backs

Back Rests for attaching rigid and semi rigid substrates.
Connectors for holding onto uprights are included.

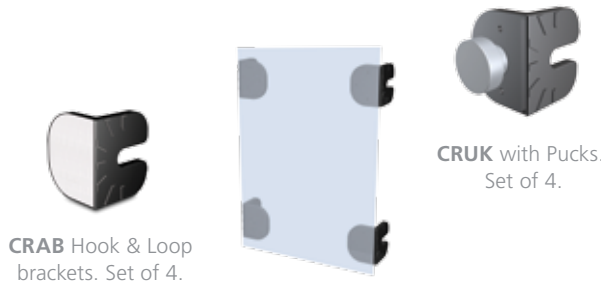

CRAB Hook & Loop
brackets. Set of 4.

CRUK with Pucks.
Set of 4.

Puck Mounts

Sometimes pucks alone can provide
an excellent mount for graphics.



CRGP Puck
with glide screw.

Graphics Drive Sales



Many of our accessories are designed to integrate with graphics.

Retractable Crossbar

Easy to use, safe means of storing graphic, economical because it eliminates need for top crossbar.

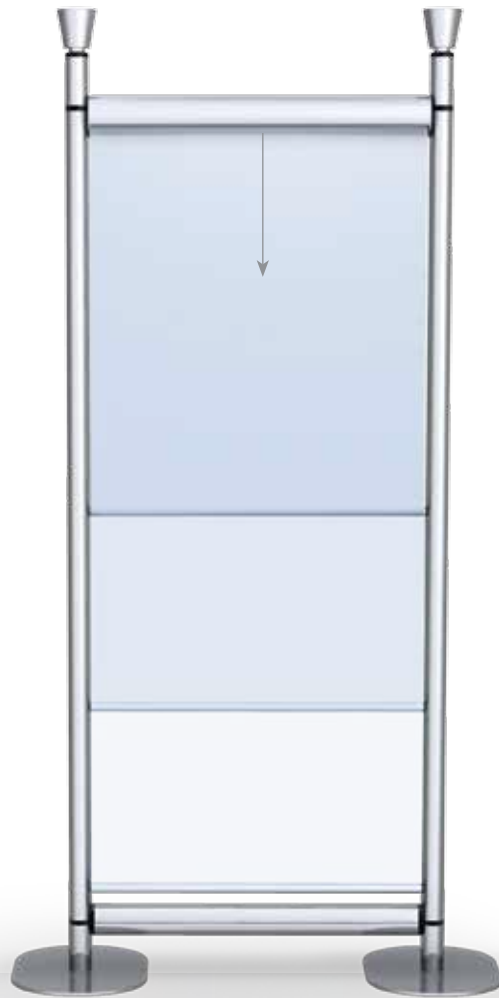

Hook & Loop Bars

Set of 2 bars, a top & bottom, connectors included.

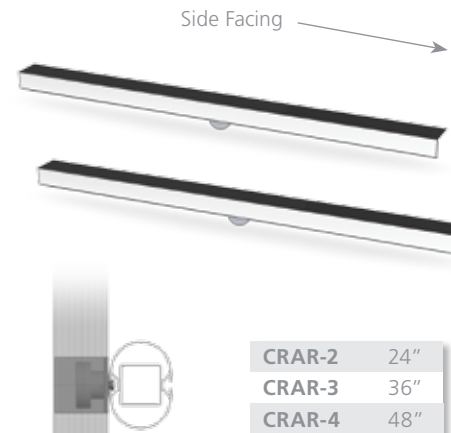
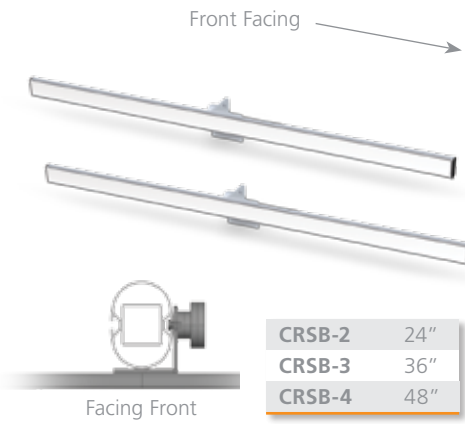

Aluminum Frames

Aluminum Frames

Satin anodized silver frames, viewable 2 sides, 3/16" full top entry slot. Mounting hardware included.



Tool-free Assembly!!

Precise miters and handsome satin finishes.

Mounting options:
(Mounting hardware included).



CRPX1	8-1/2" x 11"	CRPX4	14" x 22"	-C Center*
CRPX2	11" x 14"	CRPX5	22" x 28"	-D Side
CRPX3	11" x 17"	CRPX6	24" x 36"	-R Crossbar

*Mount type does not affect costs



Live area: All frames have a 3/8" margin.

Easy-Open Aluminum Snapframes

1-1/4" wide, 9/16" deep. Accepts posters and paper signs to 1/32" thick. Rigid opaque plastic backing, Matte overlay lens and mounting hardware included.



CRME7	22" x 28"	-C Center*
CRME9	24" x 36"	-D Side
CRME10	30" x 40"	-R Crossbar

*Mount type does not affect costs



^
Center mount
aluminum frames. >

62303



Tool-free
Assembly!!

Custom
models available.

62304



^
Custom frames mounted
between two uprights.

62305

Swivel Frames - Side Swivels

Frames swivel for multi-angle presentations.
Mounting hardware included.



CRSV0	11" x 17"
CRSV1	22" x 28"
CRSV2	24" x 36"
CRSV3	30" x 40"

Other sizes available.



Precision miters



3/8" margin covered by the frame

Custom sizes &
layouts available. >



62395

Shelving

Mobile Marketing - Modular Construction



62306

Clear Acrylic Shelves
Mounting hardware included with each shelf.



CRSS Square Shelf
3/8" x 10"



CRRS Round Shelf
3/8" x 12"



CRSF Shoe Shelf
3/8" x 4" x 10"



CROS Oval Shelf
3/8" x 12" x 8"

Inclinable Shelves

12" deep steel powder coated, shelves tilt by engaging uprights in center. There is a lip on both sides. Graphics cannot extend behind.

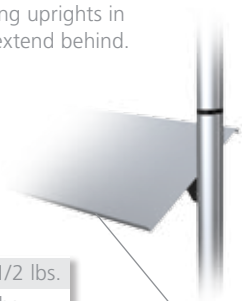

CRIS-24	24"	3 lbs.	CRIS-36	36"	4-1/2 lbs.
CRIS-30	30"	4 lbs.	CRIS-48	48"	6 lbs.

Regular Shelves

12" deep, steel powder coated, cantilevered in front of the uprights. Shelf brackets required. Graphics and panels can fit behind. Two units can be positioned back to back.

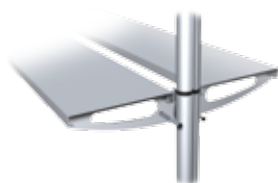
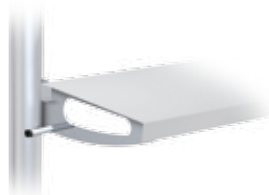

CRST-24	24"	4 lbs.
CRST-30	30"	5 lbs.
CRST-36	36"	6 lbs.
CRST-48	48"	8 lbs.

Shelf Brackets for Regular Shelves

Connectors included.



CRSB Set of 2, a left & a right Single Shelf Bracket.

CRDB Double Shelf Bracket, for center upright.

Graphics positionable behind regular shelves and many other accessories.



62307

Cafe Shelves

Cafe Shelves

Offered in two materials.
Mounting hardware included.

- White stress relieved 1/2" POLYPROPYLENE. Modern high end look, will not react chemically with cosmetics.
- White or black MELAMINE clad 5/8" MDF with rubber "T" molding. Suitable for high traffic areas.



	18" Half Rd	24" Half Rd	36" Half Rd
Black Melamine	CRHM1-B	CRHP2-B	CRHP3-B
White Melamine	CRHM1-W	CRHP2-W	CRHP3-W
White Polypropylene	CRHP1	CRHP2	CRHP3



	18" Round	24" Round	30" Round
Black Melamine	CRRM1-B	CRRM2-B	CRRM3-B
White Melamine	CRRM1-W	CRRM2-W	CRRM3-W
White Polypropylene	CRRP1	CRRP2	CRRP3

Clear Vitrine



CRVTR Acrylic five sided - 11-3/4" cube.
-S Side Mount -C Center Mount
Connectors included.



Frosted Shelf



CRFS 11-3/4" x 11-3/4" x 11-3/4".
Frosted acrylic shelf, side mounts.
Puck connectors included.



Clear Acrylic Bowl



CRB168 16"w x 8"d. UV resistant,
high impact strength.
Includes holder and attachment.





Economical Steel Shelves & Trays

Silver powder coated. Mounting hardware included.

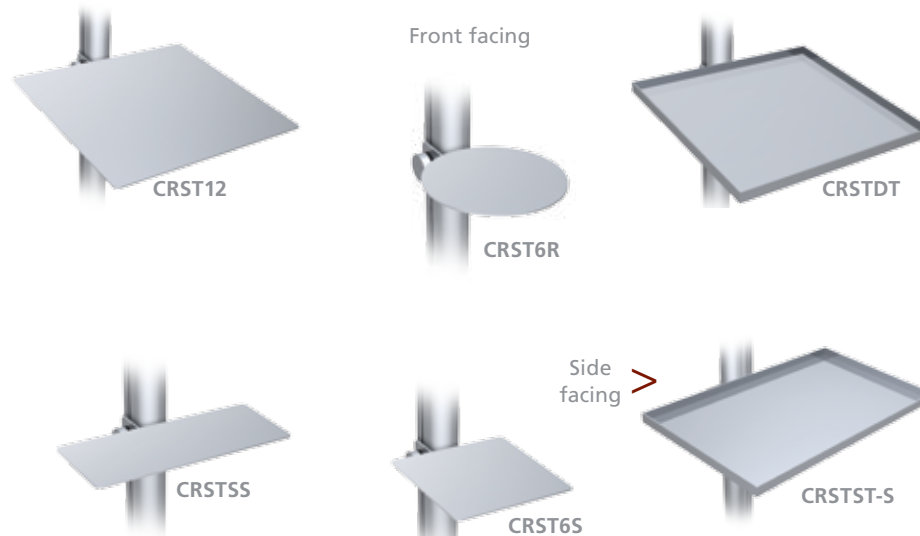

	12" Square Shelf	6" Round Shelf	12" Square Tray	10" x 16" Shirt Tray	4" x 10" Shoe Shelf	6" Square Shelf
Front Facing	CRST12	CRST6R	CRSTDT	CRSTST	CRSTSS	CRST6S
Side Facing	CRST12-S	CRST6R-S	CRSTDT-S	CRSTST-S	CRSTSS-S	CRST6S-S



Steel Shelves

Silver powder coated. 12" deep. 5/8" high lips. Mounting hardware included.

Adjustable Angle Shelf

4" x 10" Shoe Shelf with Heel stop.



CRSSL Left
CRSSR Right



CRF1
24" wide



CRF2
30" wide



CRF3
36" wide

Extra Brackets, Connectors & Bases

Knob Rests, Puck Mounts



CRKR Knob Rest & glide screw.



CRTP Rest, glide screw, & tightening puck.



CRGP Puck glide.

Saddle, Bracket



CRSD Saddle includes 2 Knob Rests.



CRAG Right angle bracket. 3 positions, Knob mount.

Kiosk Base Assemblies



CRKB1 Single



CRKB2 Double

16" square bases with either a 15-3/4" square white polypropylene top or a 47-1/2" x 15-3/4" rectangular one. Tops are desk height, 30" off the floor. The wide model accepts 30" wide crossbars.

Hanging J Hook



CRJH J Hook
Hang jewelry, hand bags, etc.
Puck connector included.



Base Options:



Simple laser cut base logos, available in quantity.



Casters available for bases. Price on application.

Set Joiners

Solid metal brackets join uprights together. Set of 2. Position where sections meet.



CRC6 60°
CRC9 90°

CRC5 135°
CRCA Adjustable

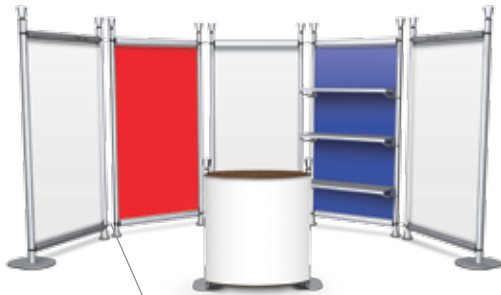

Set Joiners keep partitions together.

Panels - quoted on a project basis.
Hundreds of available standard accessories:



Steel Pegboard

- Perforated 19 gauge steel
- 1/4 holes 1" on center
- Powder coated finish
- Limitless possibilities

- Shelves
- Hangers
- Hooks
- Face Outs
- Baskets
- Signage
- Waterfalls
- Hat / Cap Racks
- Lit. Holders
- Jewelry Displays



Aluminum Slatwall

- 1" on center aluminum alloy
- Etched & clear satin anodized
- Lightweight & strong
- Beautiful, modern design

Tower Tops



CRTJ2 2 way top.

Steel plates attach to threaded pole tops with included knobs (tool-free) or machine screws.



CRTJ4 4 way top for X Tower.

Tower Bases



Base for Tri Towers.

CRBTRI



Base for Quad Towers.

CRBQD



Base for X Towers.

CRBX



Base for T Structures.

CRBPD

Brackets & Accessories

Wheel Holders (Side facing out).



CRWHD

Telescopic for wheels 7" - 11" wide.
Front knob has a 1-1/2" adjustment.
CRWHS Single Sided
CRWHD Double Sided

Acrylic Mirror



CRAM 10-1/2" round Acrylic Mirror framed by an 11-1/2" frosted acrylic circle. Chrome plated 12" long flexible arm and connector included.

iPad Holder

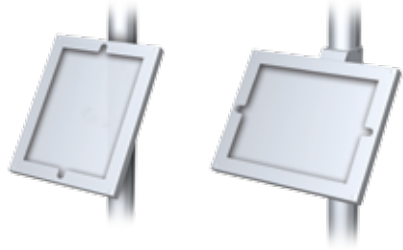

CRIH Mounts to any upright and swivels horizontal to vertical. Tamper proof hardware included (not tool-free).

Pamphlet & Catalog Holders

Connector included.



CRCH Catalog Holder 9" w x 1-1/2" d, clear.

CRPH Pamphlet Holder 4-3/8" w x 1-1/2" d, clear.



62380

Video



CRVX Fixed universal monitor mount. 24" max. Connectors included.



CRVA Swiveling universal monitor mount. 22" max. Connectors included.



62325



CRWM Wire management clips. Holds 6 mm & 10 mm cables. (set of 4).



62331

CRPB Plasma Brackets. Must hang top and bottom from two crossbars, set of 2, 20" long. Universal mounting holes. Use 42" maximum monitor.

Steel Lit. Holders

Connector included.



CRLF Lit. Holder Steel 9" x 11-3/4", centered mount.



CRLS Lit. Holder Steel 9" x 11-3/4", Select left (-L) or right (-R) mount.



62377



62395

Accessories

Waterfalls

5 slot and 7 slot steel brackets for garment hangers.
Puck connector included.



Attach to uprights

CRWF5	5 slots
CRWF7	7 slots

Attach to crossbars

CRWC5	5 slots
CRWC7	7 slots

Garment Brackets & Poles

Heavy wall poles, brackets and pucks. Connectors included.

Extended units



Singles

CREGS-2	24"
CREGS-25	30"
CREGS-3	36"
CREGS-4	48"

Doubles

CREGD-2	24"
CREGD-25	30"
CREGD-3	36"
CREGD-4	48"

Centered units



CRCG-3	36"
CRCG-4	48"
CRCG-2	24"
CRCG-25	30"

Spanning Floor to Ceiling

Includes an end treatment on both ends.

Choose Two:

- P Bolt down 5" round plate with mounting holes.
- L 2-1/2" diameter leveler.
- S Metal scissors ceiling grid clip.
- C 3" diameter suction cup.

All end treatments are the same cost.

CRUFC8	96"
CRUFC85	102"
CRUFC9	108"
CRUFC95	114"
CRUFC10	120"

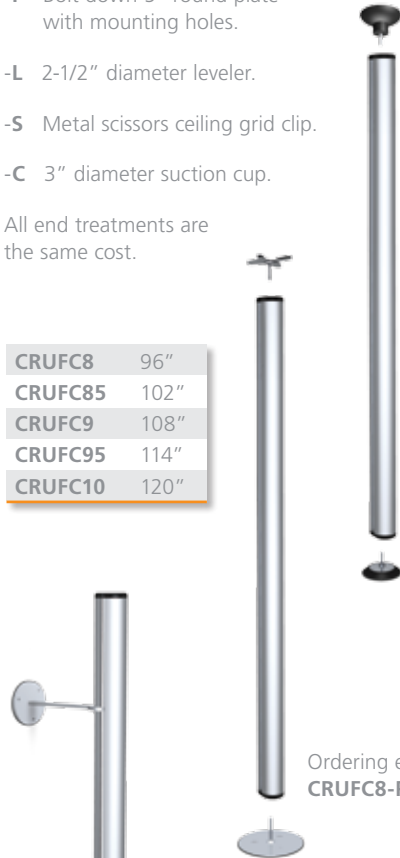

Ordering example:
CRUFC8-PS

Wall mount upright with 2 brackets, lower one 6" from bottom.

CRUW3	36"
CRUW4	48"
CRUW5	60"
CRUW6	72"



CRPWB Extra perimeter wall mount bracket. 6" stem.

Podium Tops



CRPTW Extra Birch platform with integral crossbar.

CRPTWP Same but without Velcro & undercut for graphic.



CRPTP 1/2" clear acrylic top, shown with closures.

CRPTC Set of 2 attractive top closures, 3-1/4" diameter.



4526P1 Hard Case and Insert

A perfect way to insure your podium lives a long & useful life. Well worth the initial investment.

Sample Kits

Great for demonstrating to clients CREO's quality level and ease of use. Most of our popular attachments are included.



CRPOSS Single Pole Pos



CRPOSD Double Pole Pos

Lighting



CR50 50 watt light attaches to top of cone topper.



CRLED18 18 watt LED Light.



CR150 150 watt halogen light.

Lights above attach along crossbars and include mounting hardware.

Hard Cases

Many hard cases with built-in wheels are stocked so your CREO project can be properly protected and shipped.



HC4840



HC3919	39" x 19" x 5-1/2"	20 lbs.	Thermoformed
HC4526	45" x 26" x 9-1/2"	28 lbs.	Thermoformed
HC4840	48" x 40" x 45"	115 lbs.	Thermoformed

HC5315	53" x 15" x 12"	25 lbs.	Thermoformed
HC5325	53" x 25" x 10"	34 lbs.	Thermoformed
HC6522	65" x 22" x 9"	33 lbs.	Thermoformed

HC4213	42" x 13" x 5"	11 lbs.	Fabricated Board
HC6317	63" x 17-3/8" x 12"	24 lbs.	Fabricated Board
HC6326	63" x 26" x 9-1/2"	30 lbs.	Fabricated Board

Garment Hanging



Tool-free
Assembly!!

Custom
models available.

Center Garment Brackets

Heavy wall poles, brackets and puck connectors.
Assembles centered between two vertical uprights.



CRCG-2	24"
CRCG-25	30"

CRCG-3	36"
CRCG-4	48"

Extended Garment Brackets

Heavy wall poles, brackets and pucks.
Puck connectors included.



Singles	
CREGS-2	24"
CREGS-25	30"
CREGS-3	36"
CREGS-4	48"

Doubles	
CREGD-2	24"
CREGD-25	30"
CREGD-3	36"
CREGD-4	48"



Waterfalls

5 slot and 7 slot steel brackets for garment hanging.
Puck connection included.

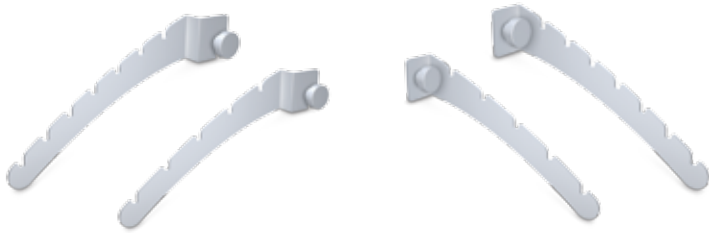

CRWF5 5 slots attaches to uprights
CRWF7 7 slots attaches to uprights

CRWC5 5 slots attaches to crossbars
CRWC7 7 slots attaches to crossbars



62317



62359

Customer Arms

Sleek metal arms, 5/8" diameter, with anodized aluminum face-out.
Also use as graphic rods with hemmed graphics.
Three available lengths. Sold individually.



CRUM1 12" Arm



CRUM2 18" Arm



CRUM3 24" Arm

Garment hanging
with graphics integration!

Perimeter



Wall Mount Uprights

Upright Sections

Two 6" Standoffs and 3-1/4" mounting plates included. End caps top and bottom. One standoff is set at 6" from upright bottom.

CRUW3	36"	CRUW5	60"
CRUW4	48"	CRUW6	72"



Wall mounted shelving units.



CRPWB Extra perimeter wall mount bracket has a 6" standoff.



< Custom sizes and units with floor levelers available.

Spanning Floor to Ceiling

Includes an end-treatment on both ends.

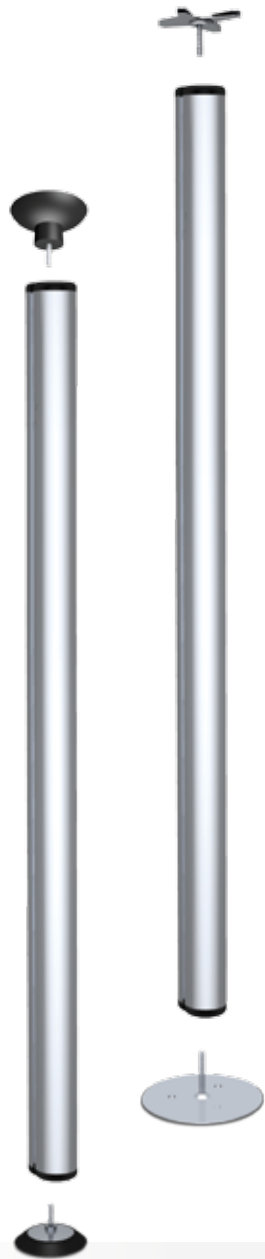

Floor to ceiling

CRUFC8	96"
CRUFC85	102"
CRUFC9	108"
CRUFC95	114"
CRUFC10	120"

CREO is modular, infinitely changeable.



Choose two end treatments for each pole.:

- P Bolt down 5" round plate, mounting holes.
- L 2-1/2" diameter leveler.
- S Metal scissors ceiling grid clip.
- C 3" diameter suction cup.

All end treatments are the same cost.

Simply add 2 designations after part # to indicate end treatments, ie:

CRUFC9-LP includes a leveler and a mounting plate.

CRUFC10-PS includes a mounting plate and a ceiling scissors clip.

CRSLO Spring Loaded Option mechanism fits between upright and end treatment. Order separately.

Aluminum Slatwall



62320

1" on center Slatwall
has a clean modern look

Hundreds of standard Slatwall accessories:

- Shelves
- Hangers
- Hooks
- Face Outs
- Baskets
- Signage
- Hat Racks
- Cap Displays
- Waterfalls
- Lit. Holders
- Jewelry Displays
- Shelf Brackets

Aluminum Slatwall



- 1" on center aluminum alloy
- Etched & clear satin anodized
- Lightweight & strong
- Beautiful, modern design



62351



62321

Steel Pegboard

- Perforated 19 gauge steel,
- 1/4" holes 1" on center
- Powder coated finish
- Limitless possibilities



Accepts all
Pegboard accessories



Tool-free
Assembly!!

Video Displays

Video - Multimedia Display Made Simple!



CRVA Swiveling universal monitor mount. 22" maximum monitor. Connectors included.

Tool-free Assembly!!

Use monitors with built in DVD players or SD Cards.



CRVX Fixed universal monitor mount. 24" maximum monitor. Connectors included.

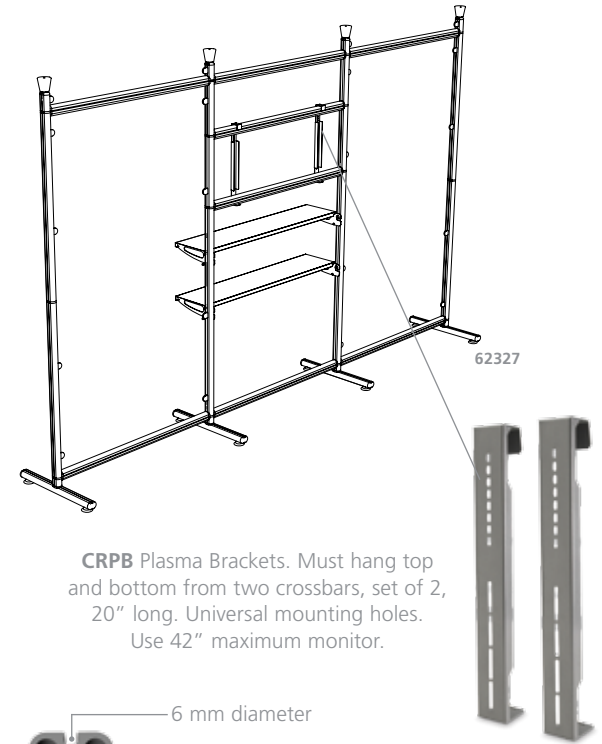

CRPB Plasma Brackets. Must hang top and bottom from two crossbars, set of 2, 20" long. Universal mounting holes. Use 42" maximum monitor.

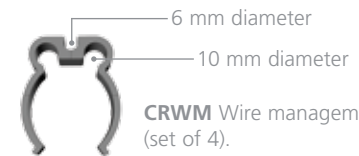

CRWM Wire management clips. (set of 4).





Multimedia



Demo Tables



with Shelves

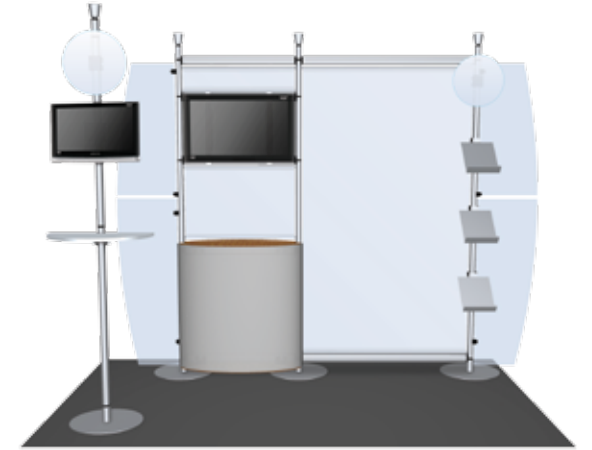

62332

Tradeshow • Exhibit



62333



62334

Kiosks

Creo Swing Frame Kiosks

Easy flip & browse. Lots of info - small footprint.
 10 satin frames. Room for 3/16" thick materials
 plus lenses. 20" square base. Height 78". Weight 55 lbs.

CRSFK1 22" x 28"

CRSFK2 24" x 36"



Accessory Lenses

CPL7 22" x 28" (2) 10 needed

CPL8 24" x 36" (2) 10 needed

White Polypropylene Shelf & Base Assemblies

Add uprights, shelves, pocket arms, graphics, video brackets, etc. - endless possibilities!



CRKB1 - 15-3/4" Square

CRKB2 - 47-1/2" x 15-3/4",
 Rectangular; accepts 30" crossbars

White polypropylene tops are
 set at 30" off floor.



Infinite number of variations available.



62335



62336



62338



Create the layout that best meets your client's goals.

Towers

Towers are dramatic and functionally efficient.



62340

Set Joiners

Solid metal brackets join uprights together.
Set of 2. Position where sections meet.



62341

Pivoting Crossbars

Economical, requiring only one upright and base at each junction. The downsides are larger gaps at corners, and accessory options are very limited.



62342



With Set Joiners, our full complement of accessories can be used, whereas with pivoting crossbars, many accessories are not compatible.

Steel Tower Bases & Tops

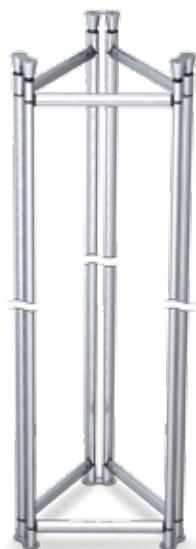

62492

Tri Towers



62493

Quad Towers



62494

T Towers

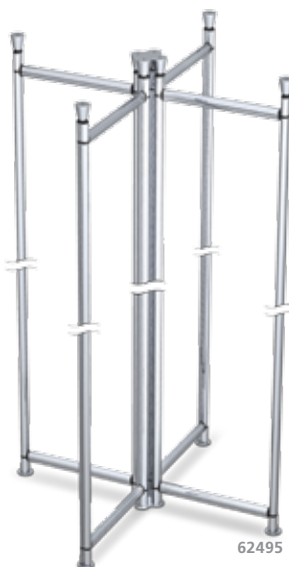

62495

X Towers



62343

TOOL - FREE ASSEMBLY!

Bases & Tops

Two upright top



With Tower bases & tops our full complement of accessories can be used. Tops include knobs (tool-free) & screws (for low profile).



X top

Tri Base



Quad Base



T Base



X Base



Crowd Control

Perfect for in line queue applications.



CREO crowd control. Tool-free assembly!



62344

Infinite number of variations available.



62345



62346

Tool-free
Assembly!!

Great graphic
integration

Graphics, signs, posts, video, panels, platforms and shelves can be added to generate impulse sales and brand awareness.

Podiums

Furniture Quality Podiums

Tool-Free Assembly - Italian Designed



6 minute assembly without tools!

CRPK1 Podium Kits

Heavy duty elliptical shaped 1/2" thick clear acrylic top.
Contemporary oval bases, substantial crossbars.

-PA Includes 2 Pocket Arms for hemmed graphics:
Graphic size: 31-1/4" wide x up to 28-3/4" high.
(please add 1-3/4" top and bottom
for pole pockets, and 1/2" bleeds on all 4 sides).

Shelf size: 36-1/4"w x 15-3/4"d
Overall size: 43-15/32"w x 43-1/2"h x 15-3/4"d.

-PG Includes 4 Panel Grippers for rigid graphics
- specify thickness, see chart page 8.
Graphic size: 30-1/2" wide x 28-7/8" high
(please add 1/2" bleeds on each of 4 sides).

Shelf size: 36-1/4"w x 15-3/4"d
Overall size: 43-15/32"w x 43-1/2"h x 15-3/4"d.



CRPK1-PA



Pocket Arm



Panel Grippers



CRPK1-PG



Podium Kit Case and Insert

45" x 26" x 9-1/2" rugged thermoformed case.
Has straps with buckles, handles, & built-in wheels.
Included is a fabricated custom cut-out polyethylene insert with an extra corrugated tube for rollable graphics storage.

- 4526P1** Hard Case and Insert
- 4526HC** Hard Case only without inserts.



Podium Kits

Two Birch oval platforms with Velcro® brand hook.
The loop comes with the graphic (not included).
Contemporary oval bases.

CRPK2 has a 1/2" thick acrylic top shelf.
The **CRPK3** does not.

Shelf size: 36-1/4" w x 15-3/4" d
Overall size: 43-1/2" w x 43-1/2" h x 15-3/4" d.

Graphic size: 83" w x 35-9/16" h
(please add 1" bleeds on each of 4 sides).
Designed to wrap completely around podium.



CRPK2 has an acrylic top shelf.



Hook-Loop Mount



CRPK3

Podiums



62347



62444



CRPK2

Tool-free
Assembly!!

Infinitely
Configurable



62350



62348



62349

Designed in Italy

Tool-free. Modular



62351



62352



62354



62353

Demo Tables

CREO Demo Table Kits

Italian design, Tool-free assembly at a reasonable price point.

Our **CREO** Demo Tables feature:

Top & Bottom gray MDF shelves 3/4" x 18-3/4" x 35-3/4"

Overall Height: 39-1/8"

Velcro® Brand Hook along top & bottom

Accepts ink-jet graphics sized: 102-1/2"w x 38-1/2"h + .5" bleeds on each of 4 sides. Front panel viewing area is 32" wide.



- Italian Design, Made in the U.S.A.
- Extremely strong, these structural uprights can hold substantial accessories, 84" overall height.



CRDMK6 Creo Demo with literature holders & monitor.

Model	Style
CRDM	Basic Mobile Demo Table (no upright)
CRDMK5	Creo Demo, 1 upright, 1 internal shelf
CRDMK5C	Same with hard plastic case
CRDMK6	Creo Demo, 1 upright, internal shelf, ink-jet graphic
CRDMK6C	Same with hard plastic case
CRDMK7	Creo Demo, 2 uprights, 1 internal shelf
CRDMK7C	Same with hard plastic case
CRDMK8	Creo Demo, 2 uprights, internal shelf, ink-jet graphic
CRDMK8C	Same with hard plastic case

Note: In quantity, lower cost options include no inner shelf & plain upright top.



CRDMWR Ink-Jet digital wrap. 102-1/2"w x 38-1/2"h has mounting Velcro® Brand Loop along top & bottom.



CRDM5H Extra shelf includes mounting hardware and sits flat inside unit. 12"x 30". There is room for two shelves inside each stand.



HC3919 Rugged thermoformed polyethylene. Built-in durable wheels and handles. 39" x 19-1/4" x 5-1/2" high. Weight 20 lbs.



64802



64803



62330



64804

All accessories include mounting hardware.



CRPA25 Pocket Arms for hemmed graphics between two uprights.



CRPX30 Perfex aluminum header frame for 30" x 8" graphics.



CROS Oval Shelf 3/8" x 12" x 8"



Waterfalls Garment Hangers
CRWF5 5 Slots **CRWF7** 7 Slots



CRCH Catalog Holder
CRPH Pamphlet Holder



CRPG-2.5 Panel Grippers for 3 mm graphics. Sold 2 per.

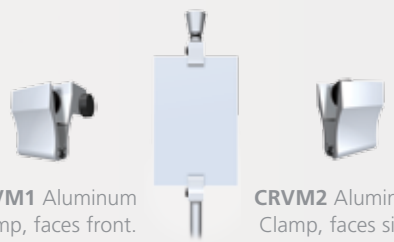

CRVM1 Aluminum Clamp, faces front.
CRVM2 Aluminum Clamp, faces side.



CRSF Shoe Shelf 3/8" x 4" x 10"

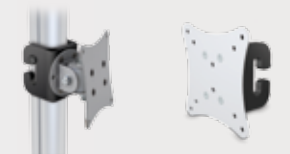

Video Mounts (19" Maximum)
CRVA Swiveling **CRVX** Fixed



CRFS 11-3/4" x 11-3/4" x 11-3/4".
Frosted acrylic shelf, side mounts.



Graphic Rods - Sleek tubes.
For hemmed graphics. Sold 2 per.

CRGR-1 18" **CRGR-2** 24"



Aluminum Side Frames
Satin silver frames

CRPX1 8-1/2" x 11"
CRPX2 11" x 14"



CRJH
J Hook



CRLS Lit. Holder 9" x 11-3/4",
left (-L) or right (-R) mount.



CRB168 Clear Dump Bowl
16"w x 8"d.

Single Pole Concepts



62355

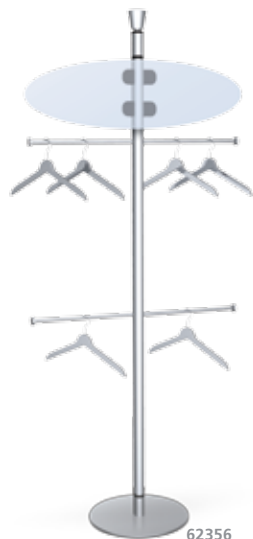

62356



62357



62358



62359



62361



62362



62363



62364

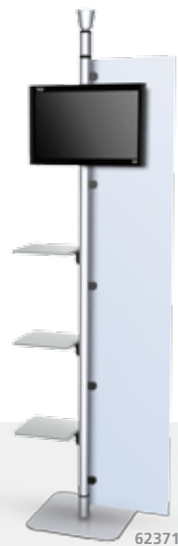

Single Pole Concepts

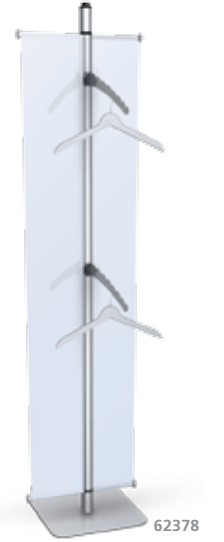



Single Pole Concepts



62301



62392



62393



62394



62395



62396



62397



62398



62399

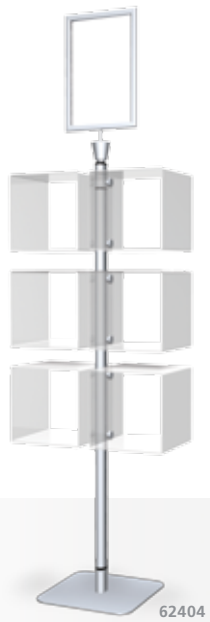
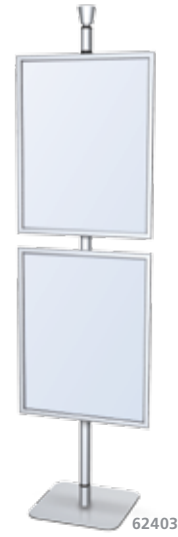
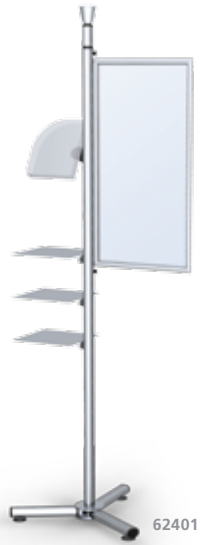
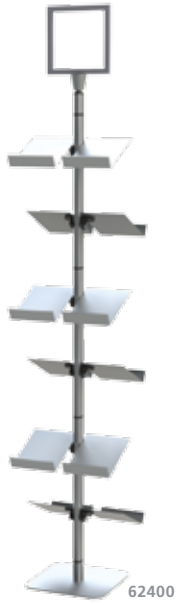

Double Pole Concepts

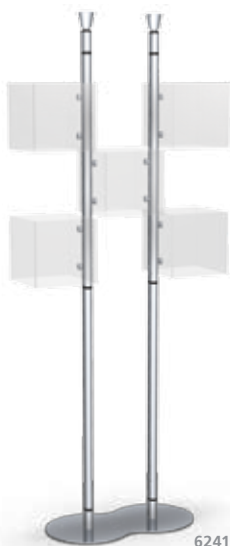



Larger Concepts





Larger Concepts



62306





62439



62441



62440

10' x 10' Exhibit Booths

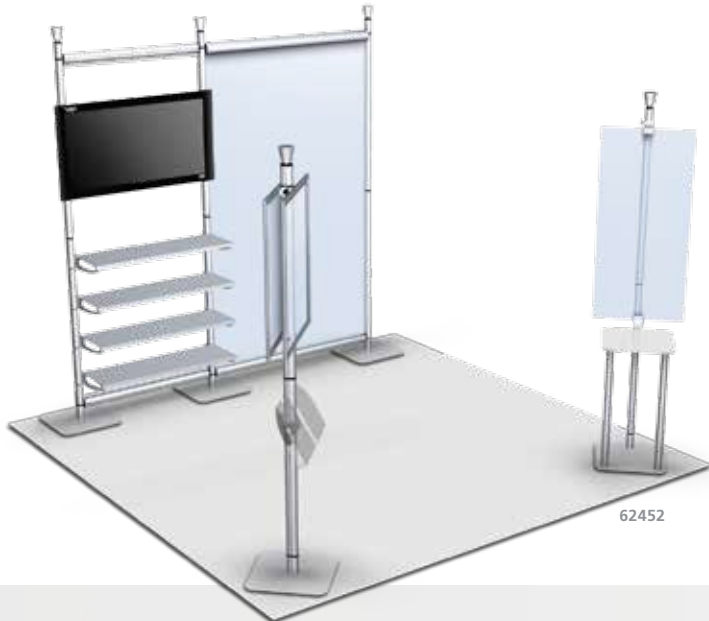
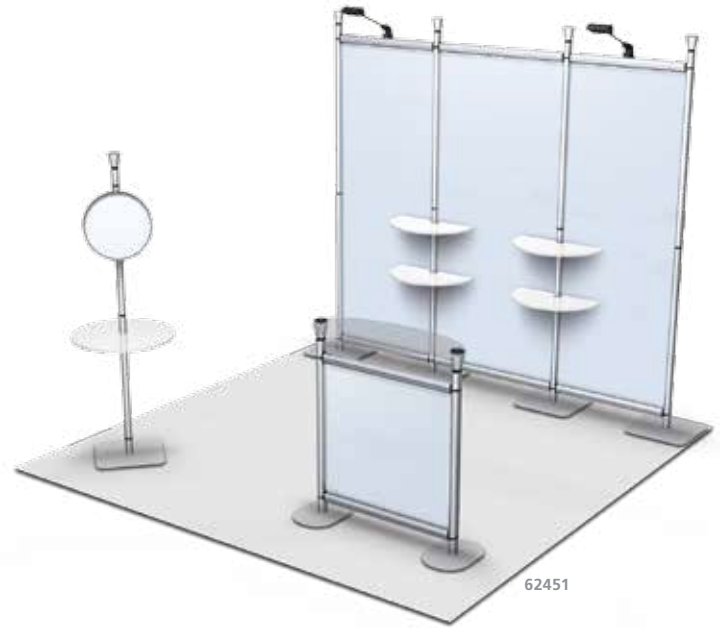

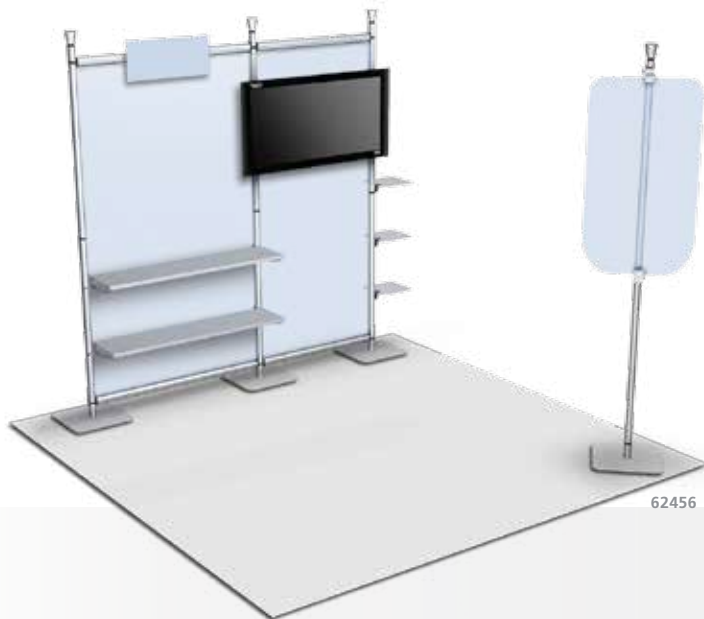

10' x 10' Exhibit Booths

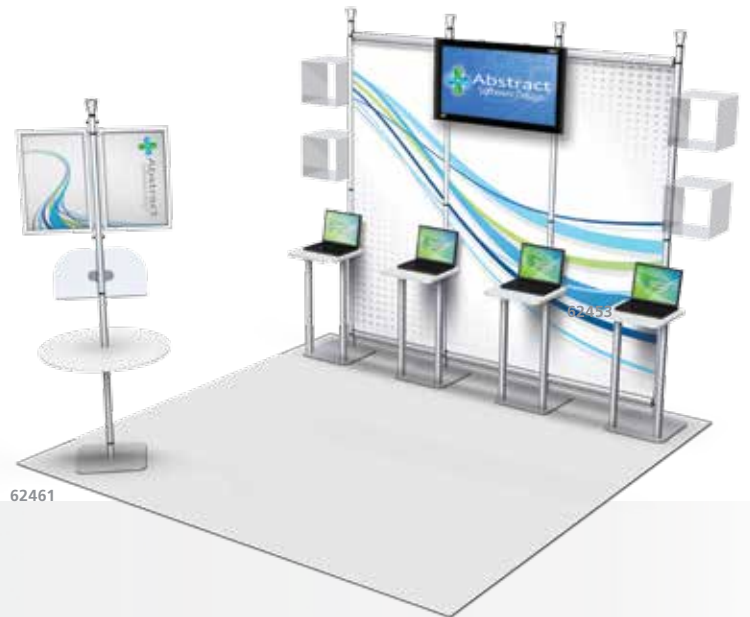



62462

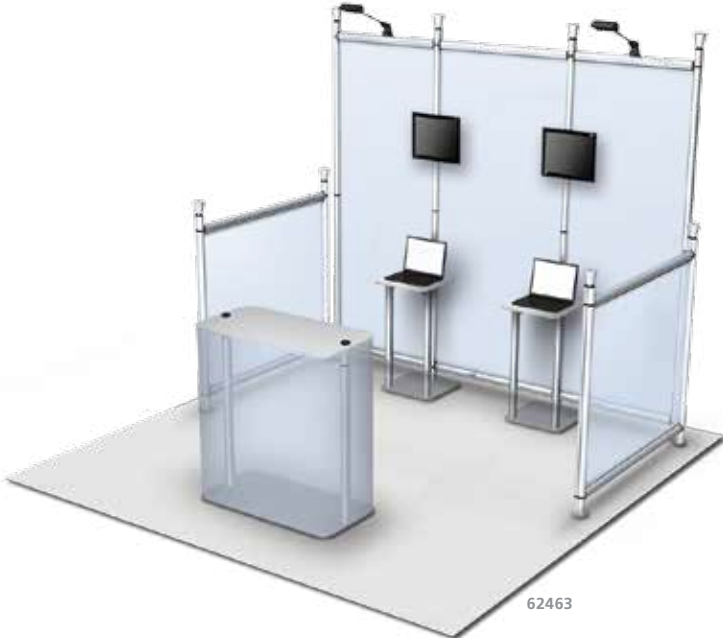

62463

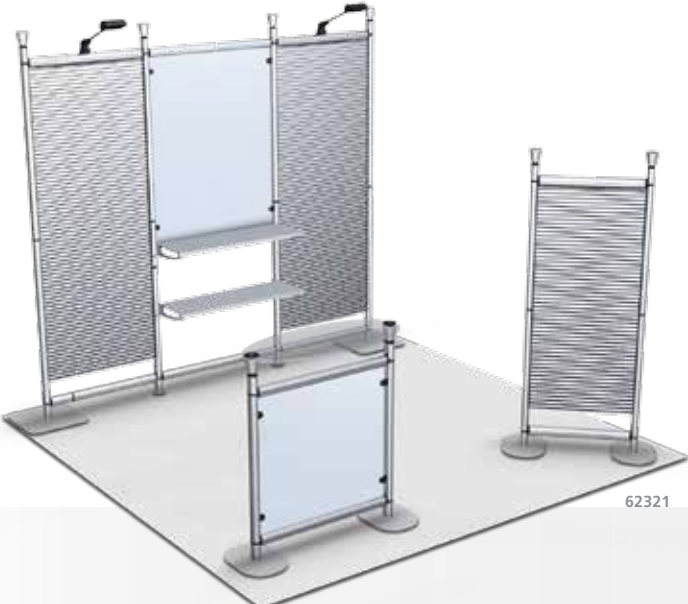

62321



62464

10' x 20' Exhibit Booths



62465



62466

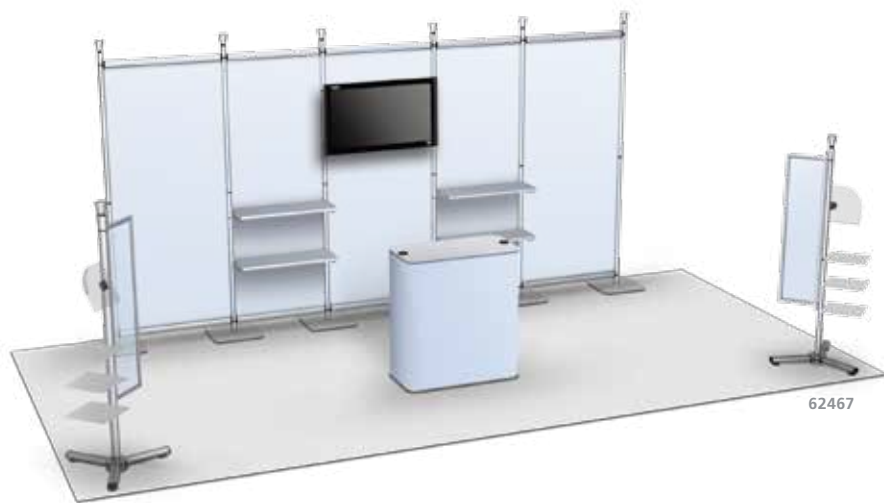

62467

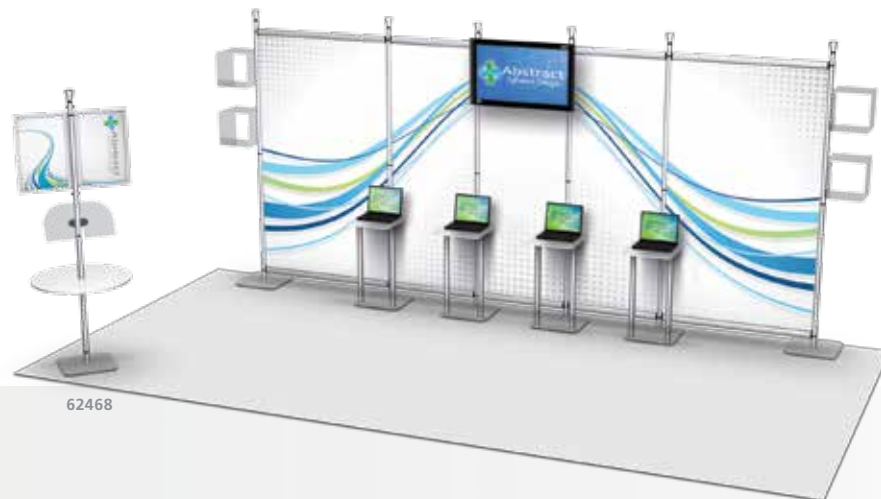

62468

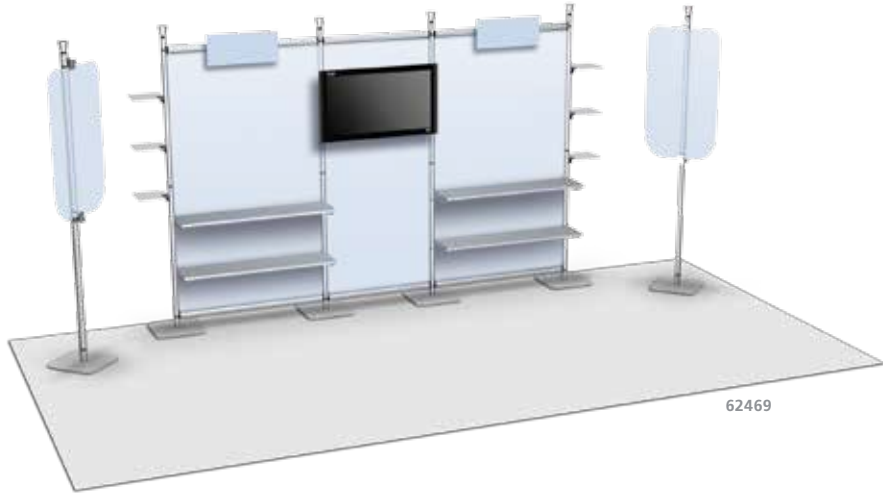

62469



62470

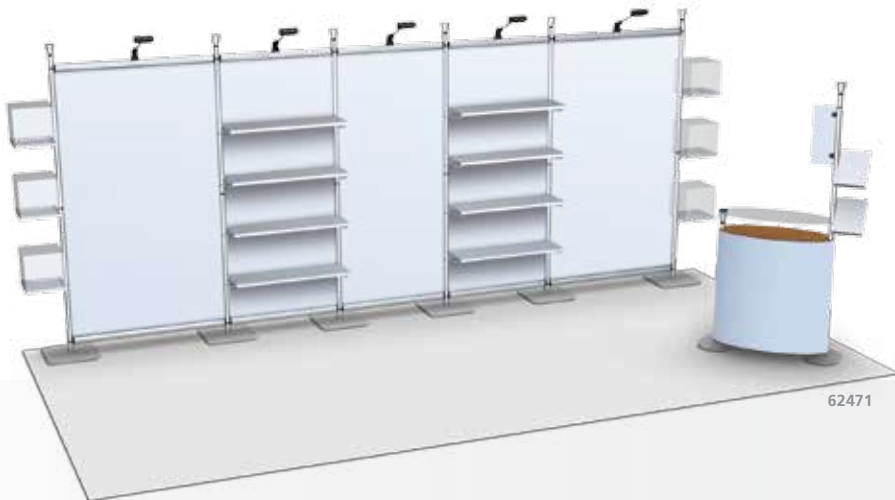

62471



62472

10' x 20' Exhibit Booths

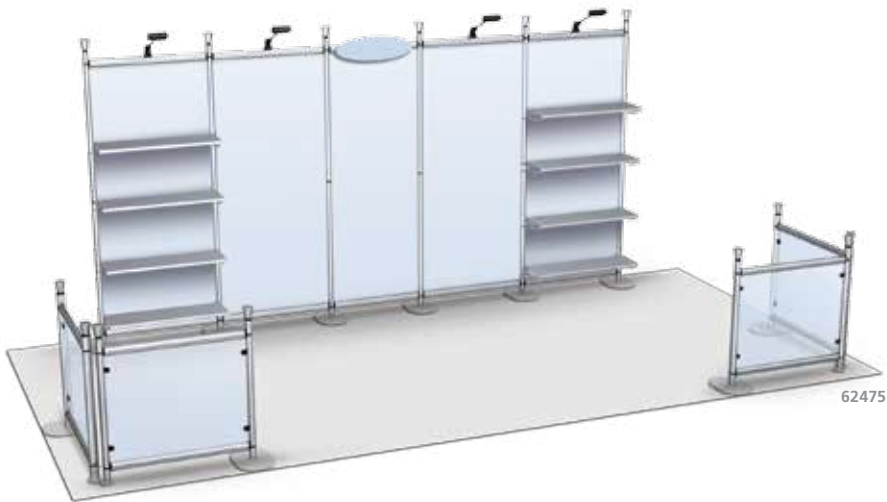
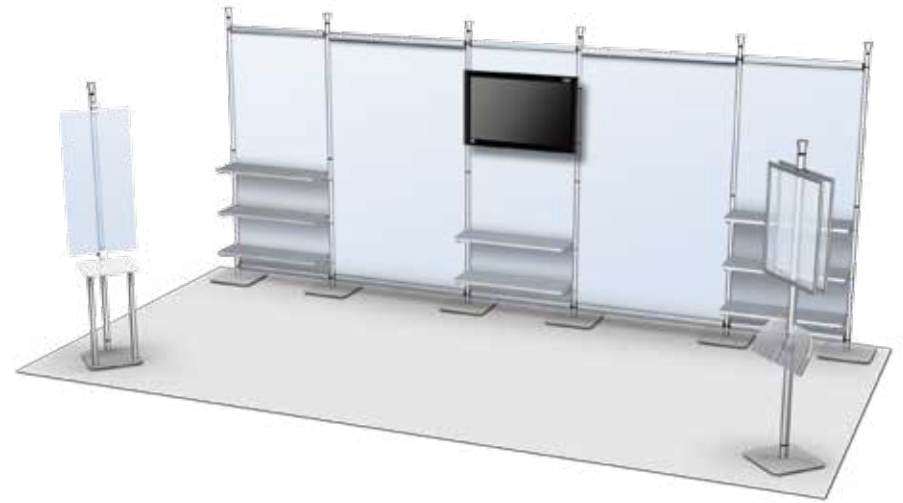

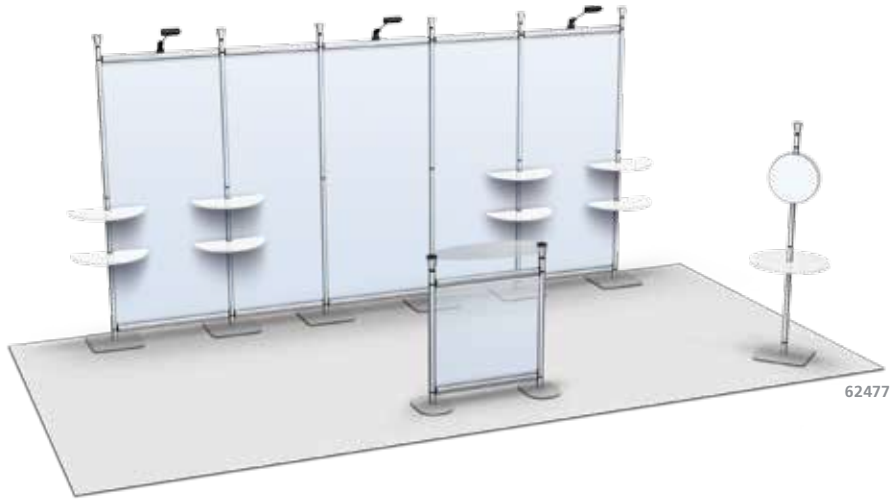

62477



62478



62479



62480

10' x 30' Exhibit Booths

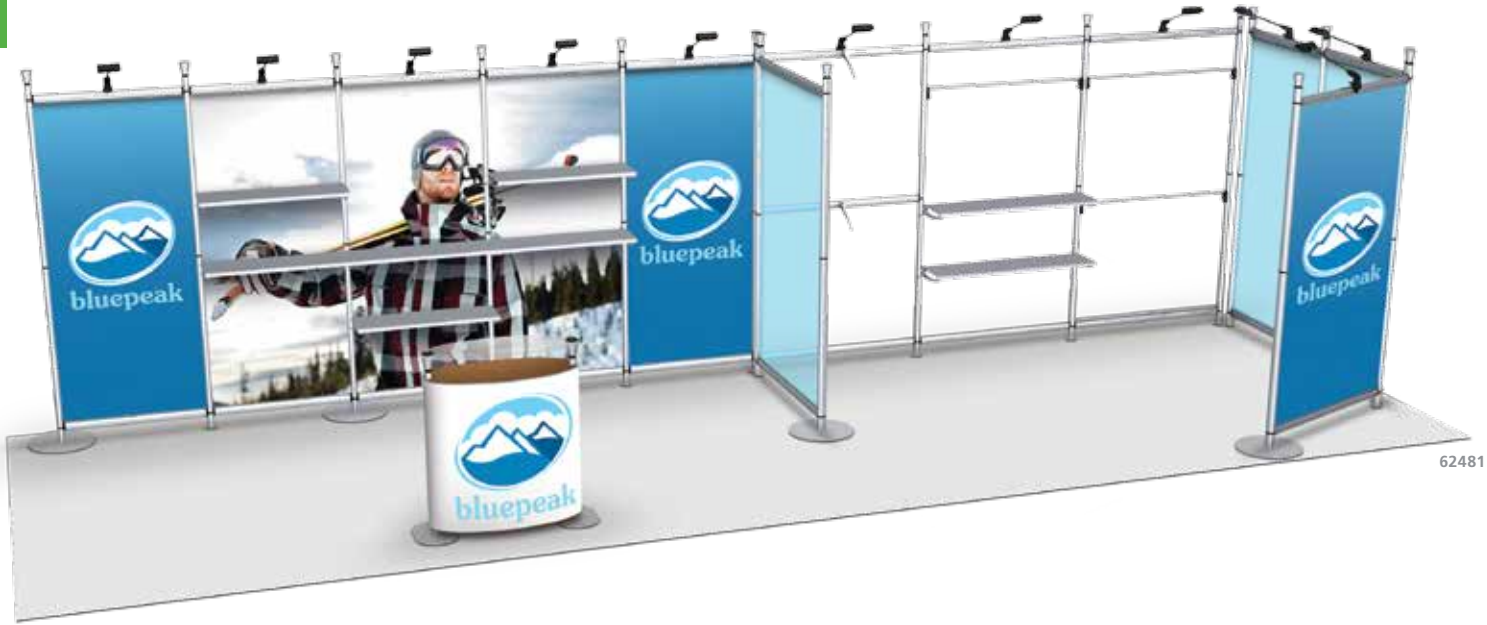



62483



62484

Larger Exhibit Booths



62485

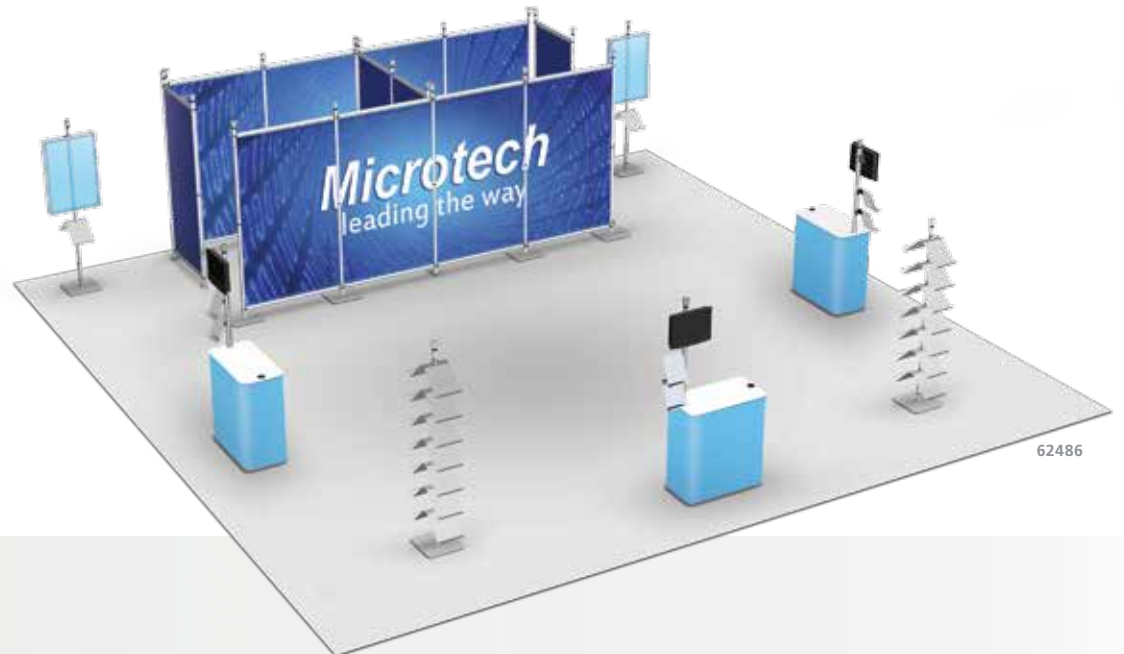

62486



62487

Assorted Structures

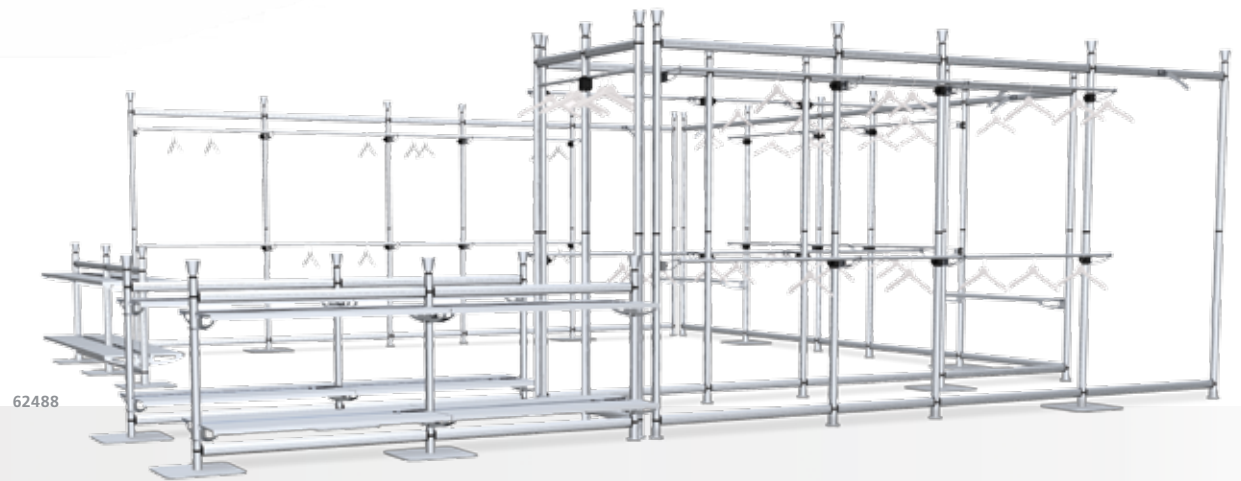

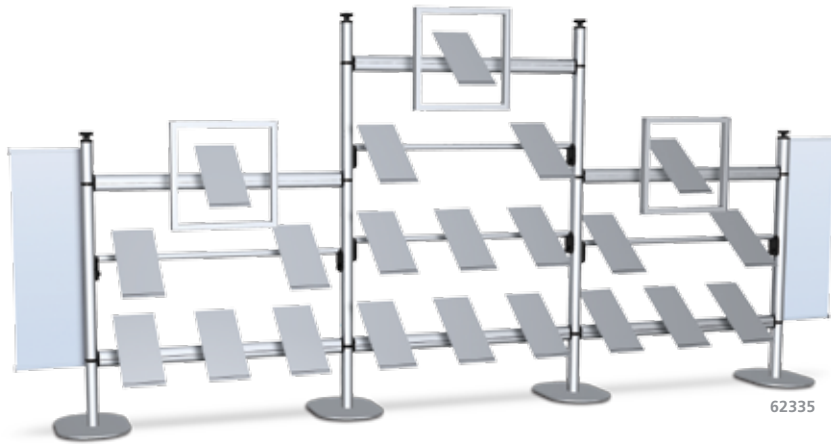

créo

Manufactured in the U.S.A.