

General Setup Instructions

Waveline Waterfall Tension Fabric



For additional information please feel free to call us at 1.800.723.2050 or visit our website at AffordableDisplays.com.

TOOLS

No tools required for standard setup.

If shelves are included, a hand tool is needed.



PARTS

(A) 2 long straight poles



(B) 4 round corner poles



(C) 2 straight corner poles



(D) 3 center support poles



(E) 2 short connector poles



(F) 2 circular feet



(G) 1 fabric graphic

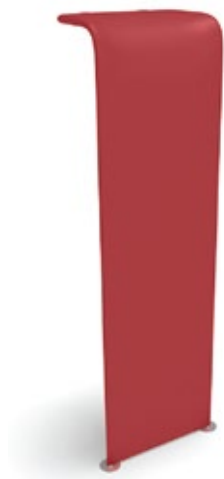

(H) 3 shelves (optional)



STEP 01

Assemble the 2 long straight poles (A).



STEP 02

Connect center support poles (D) to long straight poles (A) by pressing and pushing.

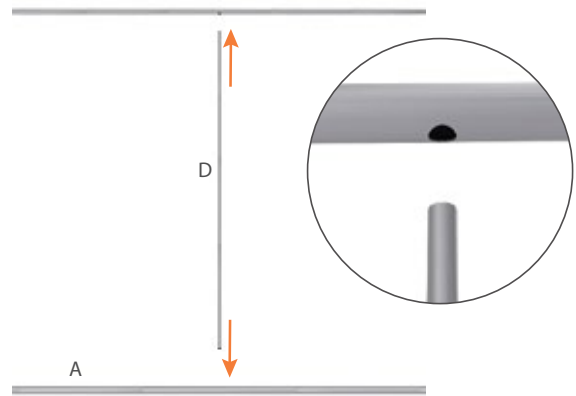

STEP 03

Connect corner poles (B, C) to straight poles (A, E) with matching shape codes. Connects by push button.

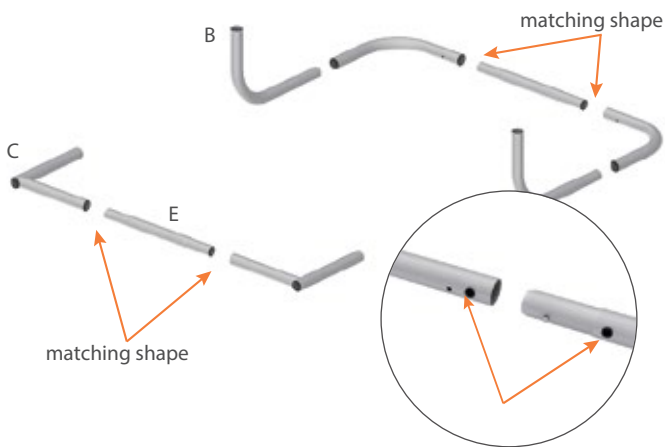

STEP 04

Frame layout.

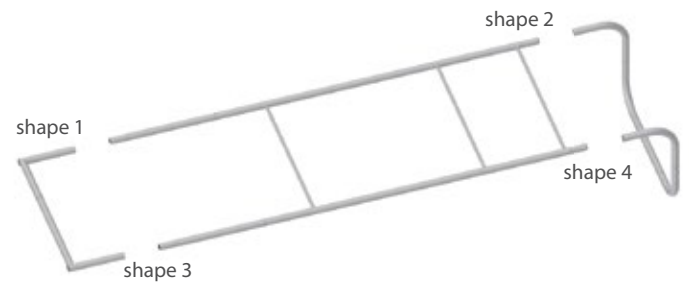

STEP 05

Unzip fabric graphic (E) and lay image face down. Slide fabric onto frame like a pillow case.

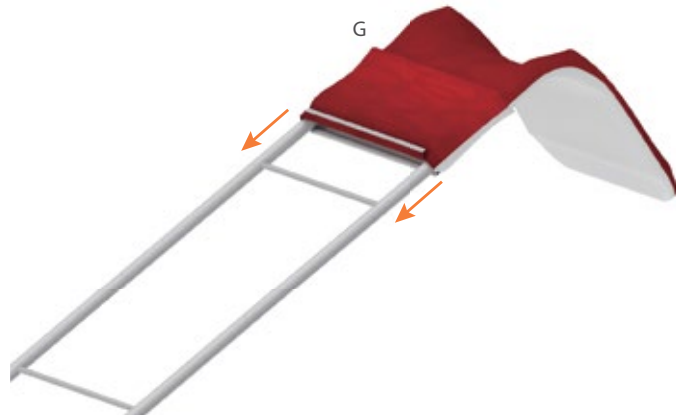

STEP 06

Connect feet (C) by pressing and pushing.

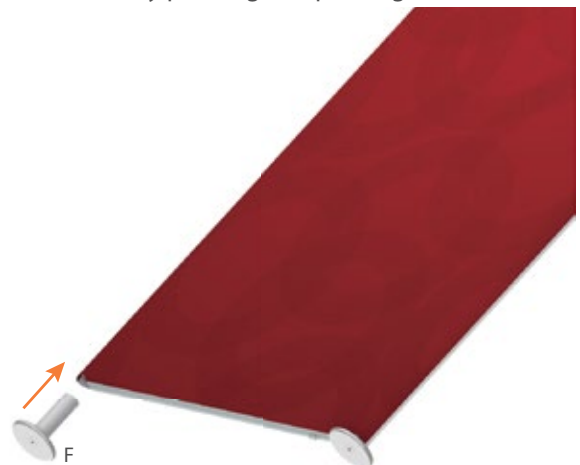

STEP 07

Zip the bottom edge of fabric graphic beyond the center point as shown.

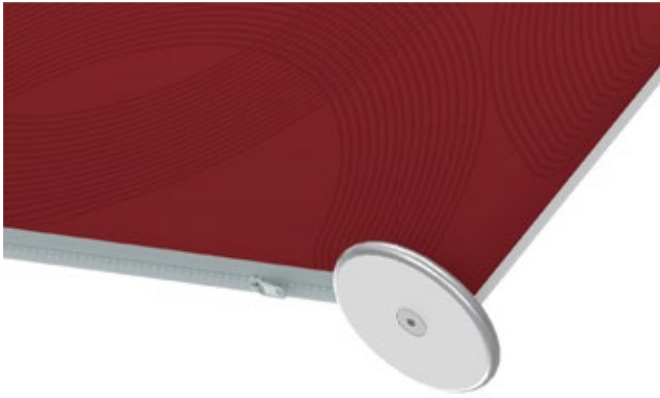

STEP 08

The shelves come semi assembled, just make sure that they are level before you tighten the clamp.

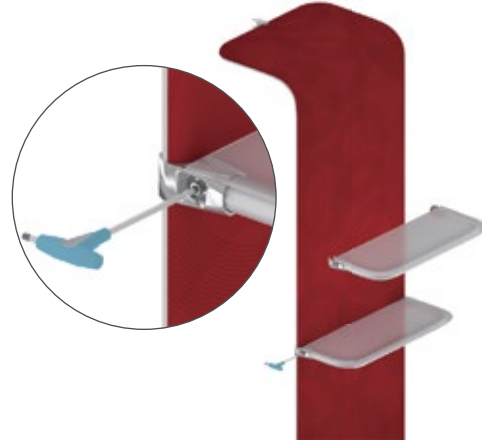

STEP 09

Position frame as desired and clamp in place on your display.

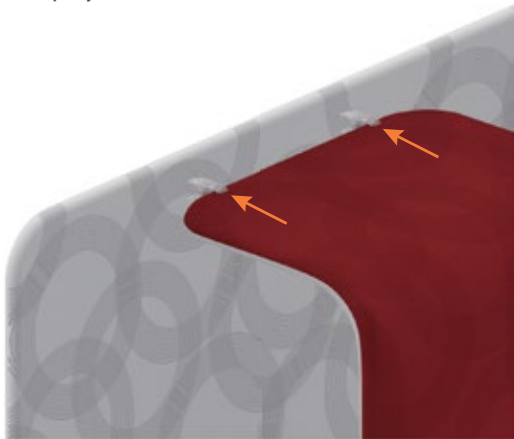

STEP 10

Complete.



For additional information please
feel free to call us at 1.800.723.2050
or visit our website at AffordableDisplays.com.