

Formulate Designer Series 10' Backwall - Kit 01

FMLT-DS-10-01

Formulate® Designer Series 10ft displays have unique stylistic features and shapes, are portable and easy to assemble. The aluminum tube frame features snap-buttons and/ or spigot connections and zipper pillowcase fabric graphics. All displays come in portable, wheeled transit cases. Simply pull the pillowcase fabric graphic(s) over the frame and zip.



features and benefits:

- Premium aluminum tube frames with spigot assembly
- Easy to store and ship
- Quick to set up
- Weighted feet for added stability
- Two zipper pillowcase fabric graphics
- Kit includes: PM453 monitor kiosk featuring the medium monitor mount, can hold 32-55" monitor / max weight 40lbs
- Lifetime limited hardware warranty against manufacturer defects

dimensions:

Hardware

Assembled unit:
116.3" w x 96" h x 50.1" d
2954mm(w) x 2438mm(h) x 1273mm(d)

Approximate weight with cases:
150 lbs / 68 kgs

Shipping

Packing case(s):
2 OCE Cases

Shipping dimensions:
OCE: Expandable case length (l) may vary
40" - 66" l x 18" h x 18" d
1016mm-1677mm(l) x 458mm(h) x 458mm(d)

Approximate total shipping weight
(includes cases & graphics):
162 lbs / 73.5 kgs

Graphic

Refer to related graphic template for more information.

Visit:
www.exhibitors-handbook.com/graphic-templates

additional information:

Graphic material:
dye-sublimation zipper pillowcase fabric

We are continually improving and modifying our product range and reserve the right to vary the specifications without prior notice. All dimensions and weights quoted are approximate and we accept no responsibility for variance. E&OE. See Graphic Templates for graphic bleed specifications.

affordable
exhibit
displays inc

Included In Your Kit

Tools, Components, & Connectors



HEX KEY SET x1



ES30 x10



PLT-BP-LN114-S2-450 x2

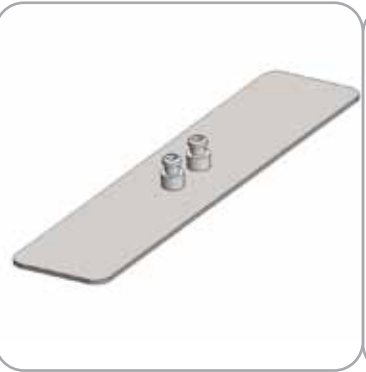

PLT-BP-LN114-S3-450 x1



ES30-90B x4



TC-30-A x2



TCP-3030-R x1



PM4S3-MK-M x1

Graphics

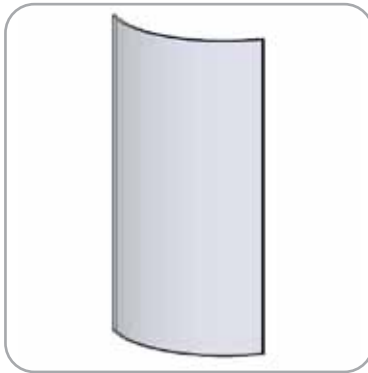

FMLT-DS-10-01-A-G x1

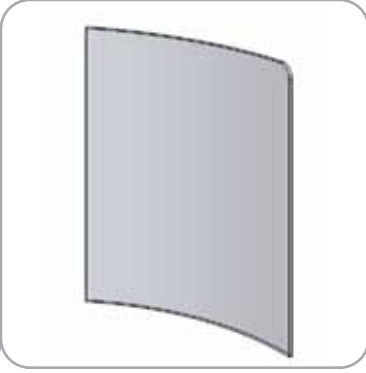

FMLT-DS-10-01-B-G x1

Included In Your Kit



DS-10-01-A-T1 x1



DS-10-01-A-T2 x2



DS-10-01-A-T3 x2



DS-10-01-A-T4 x1



DS-10-01-B-T1 x2

Tubes



DS-10-01-B-T2 x2



DS-10-01-B-T3 x2



DS-10-01-B-T4 x2



DS-10-01-B-T5 x1



DS-10-01-B-T6 x1

Exploded View

FMLT-DS-10-01

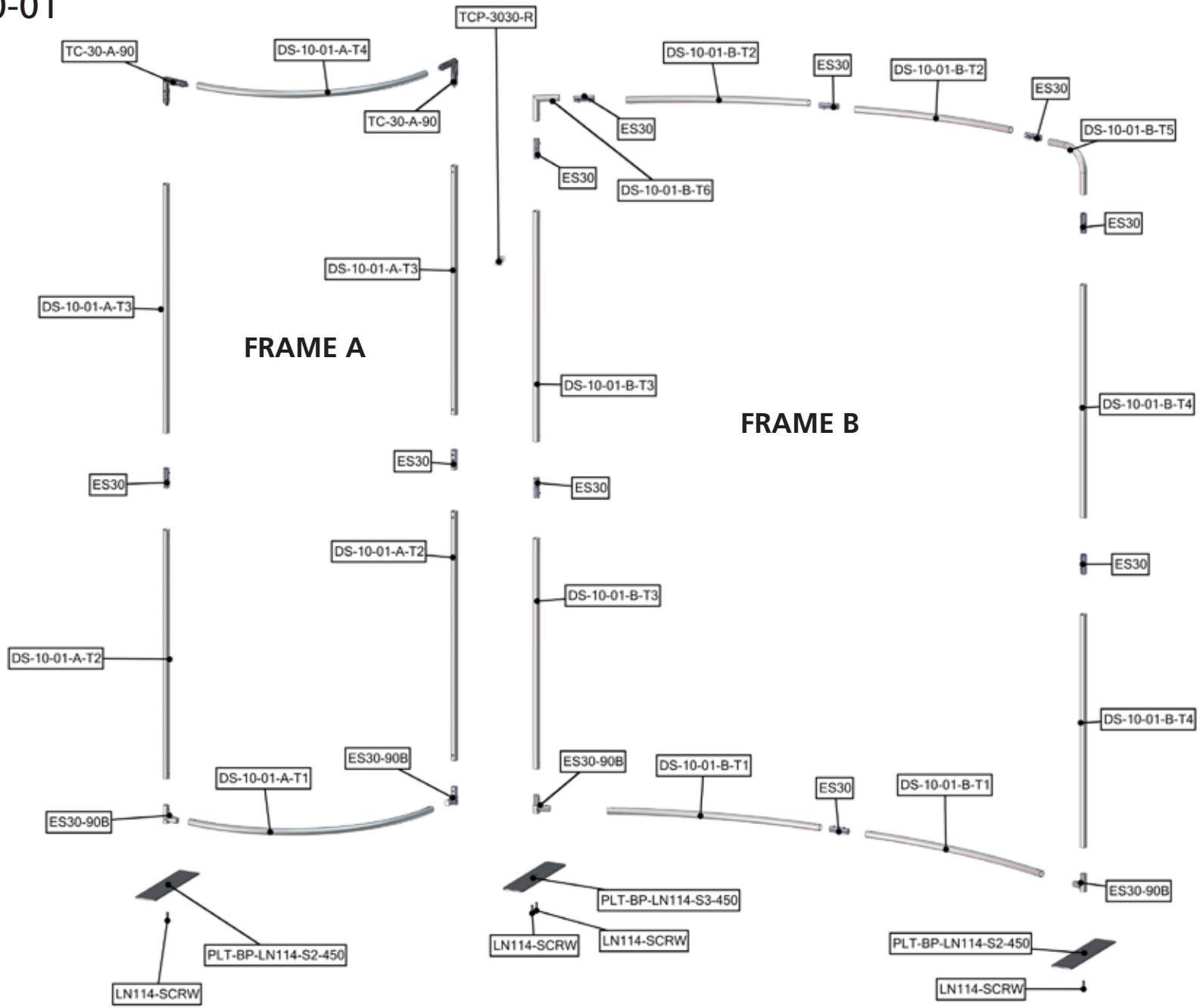

Labeling Diagram

FMLT-DS-10-01

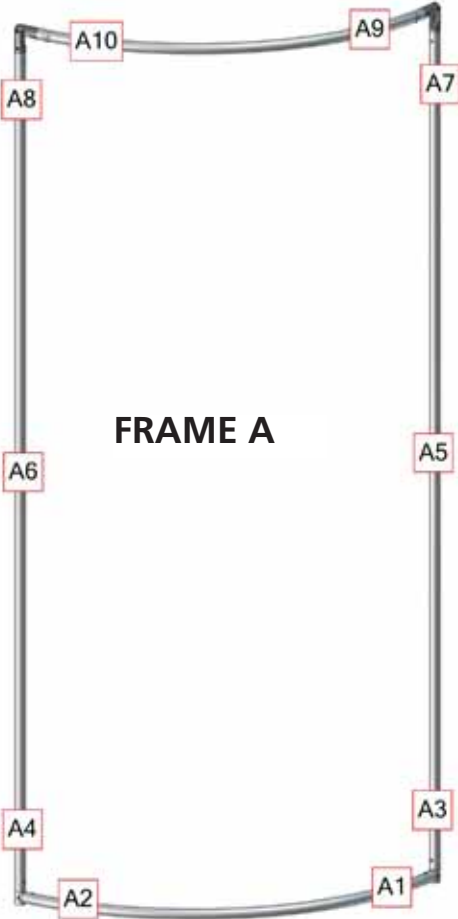

FRAME A

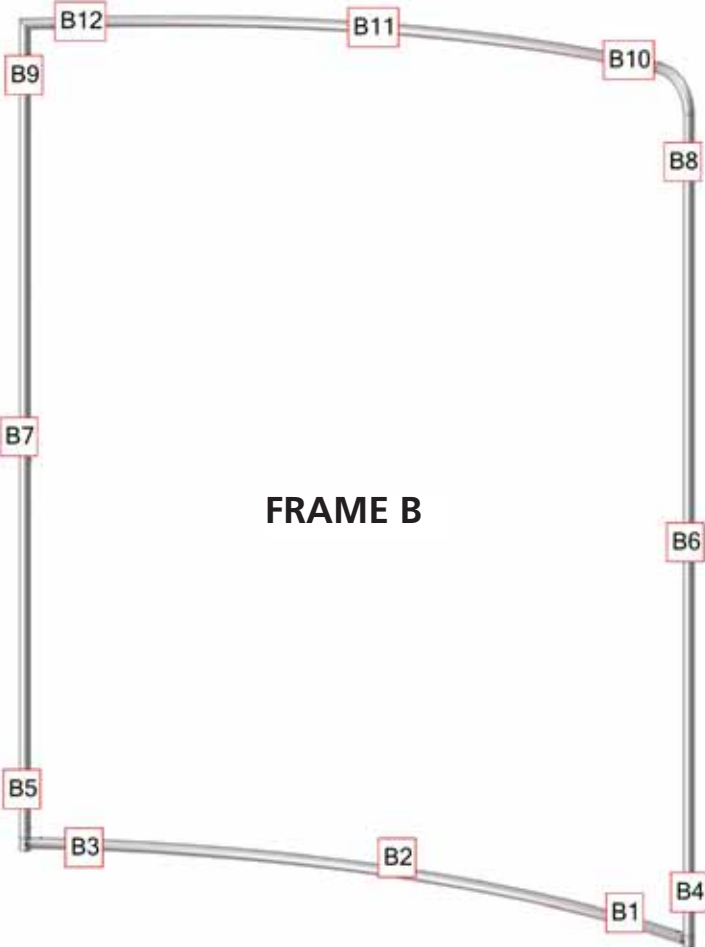

FRAME B



OVERVIEW

Connection Methods

Formulate™ structures use a number of different yet simple connection methods. Your kit will include one or more of the connection methods shown below. Steps within the Kit Assembly will reference a specific method for each connection point.

Connection Method 1: ES30 / ES50 / ES75

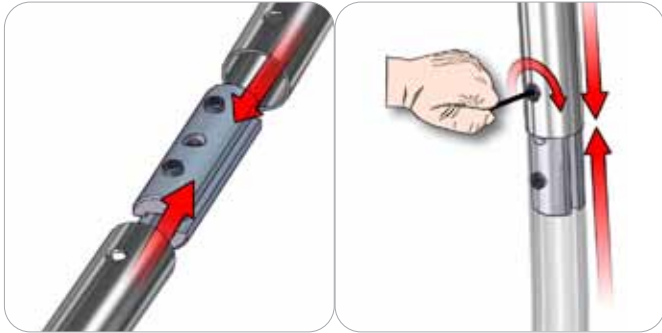

Compress the unlocked connector and slide one tube onto each end. Lock both screws carefully using your hex key tool. Be sure to lock securely, but do not overtighten.

Connection Method 2: Snap Buttons & Swage

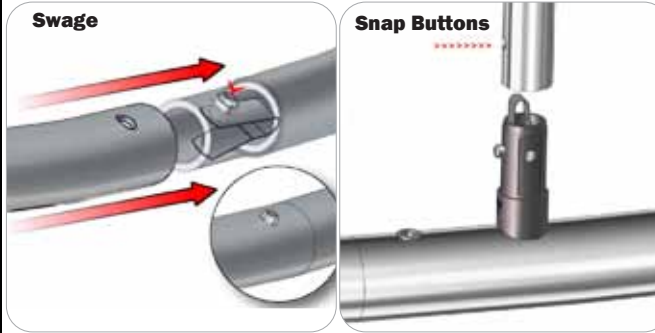

Locate the snap button on the connector or swage tube. Locate the hole on the corresponding tube. Press the snap button with your thumb and slide the tube and connector together so that the snap button snaps fully into the lock hole. To disassemble, press the snap button and pull apart.

Connection Method 3: ES30-90B / ES30-I / ES30-C



Compress one unlocked end of the connector and slide it through one tube end. Compress the other end of the connector and slide the second tube on. Lock both screws carefully using your hex key tool. Be sure to lock securely, but do not overtighten.

Connection Method 4: Tube Clamps



Be sure to fully assemble all frames before using clamps. With the clamp unlocked, place one tube of the first frame into the mouth of the clamp. Place the second tube (if applicable) into the second mouth of the clamp. With both frame's tubes in the clamp, be sure to lock securely, but do not overtighten.

Kit Assembly

Step by Step

Step 1.

Gather the components necessary for assembling Frame A and lay them flat on the floor. Assemble in the order the Labeling Diagram instructs. Lock your connectors into place using the provided hex key set.

Please reference Connection Methods 1, 2 and 3 for more details.

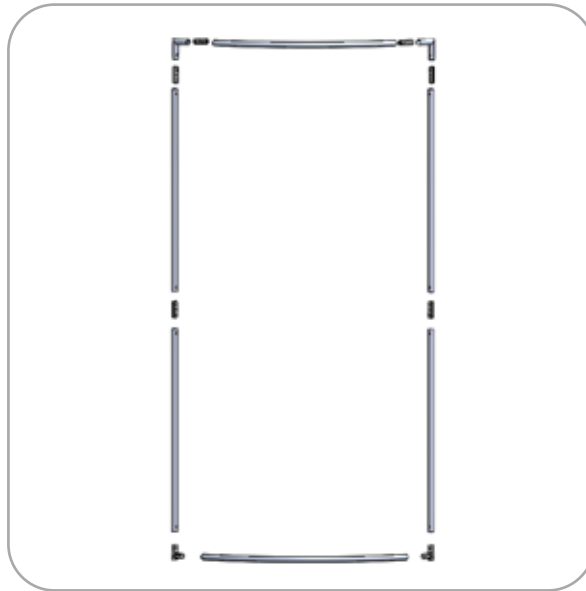

Step 2.

Gather the components necessary for assembling Frame B and lay them flat on the floor. Assemble in the order the Labeling Diagram instructs. Lock your connectors into place using the provided hex key set.

Please reference Connection Methods 1 and 3 for more details.

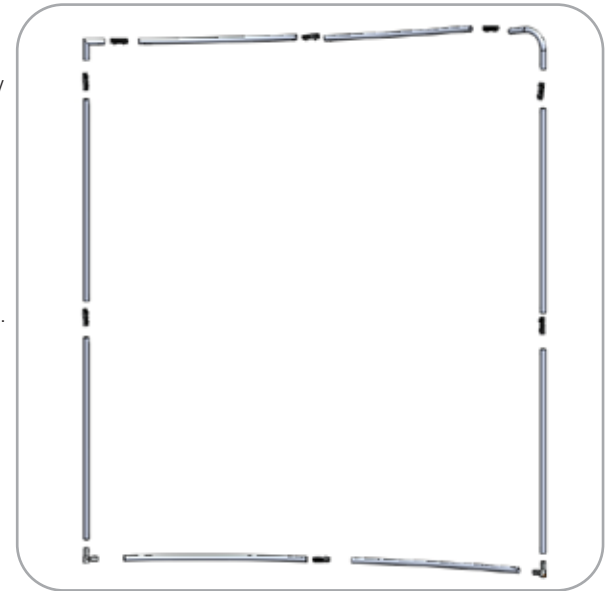

Step 3.

With Frame A laying flat on the floor, locate your pillowcase A graphic. With the pillowcase unzipped, encase Frame A by covering the frame from top to bottom.

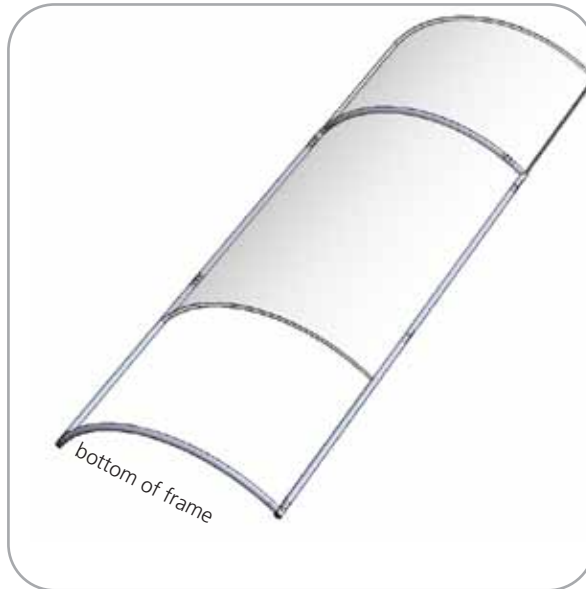

Step 4.

With Frame B laying flat on the floor, locate your pillowcase B graphic. With the pillowcase unzipped, encase Frame B by covering the frame from top to bottom.

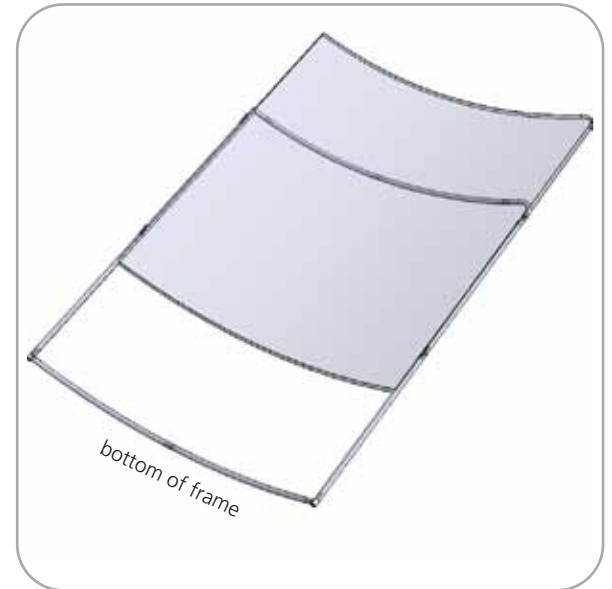

Kit Assembly

Step by Step

Step 5.

Locate the Stabilizing Base LN114-S2. Attach the foot to the left side of Frame A and the right side of Frame B. Use the hex key tool provided to lock the foot to the ES30-90B on the frames.

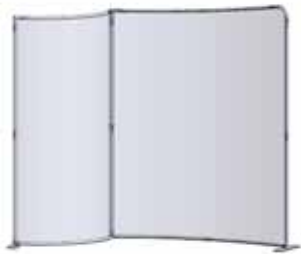

Step 6.

Locate the Stabilizing Base LN114-S3. Attach the foot to the right side of Frame A and the left side of Frame B. Use the hex key tool provided to lock the foot to the ES30-90B on the frames.

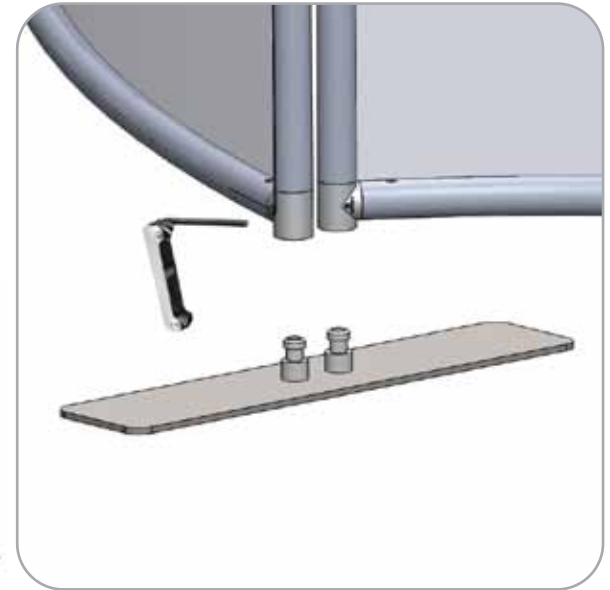
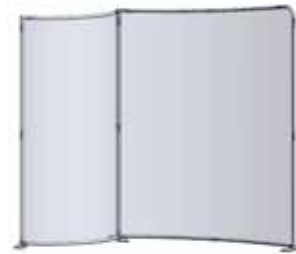

Step 7.

Use the TCP-3030-R connector to brace both frames together at the top insides of both frames.

Please reference Connection Method 4 for more details.

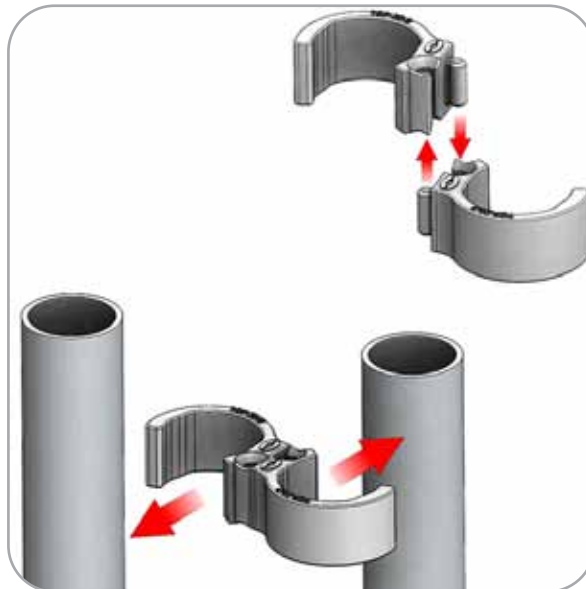

Step 8.

To complete your setup, assemble and attach the monitor kiosk behind Frame B.

Please reference the PM453-MK setup instructions for more details.

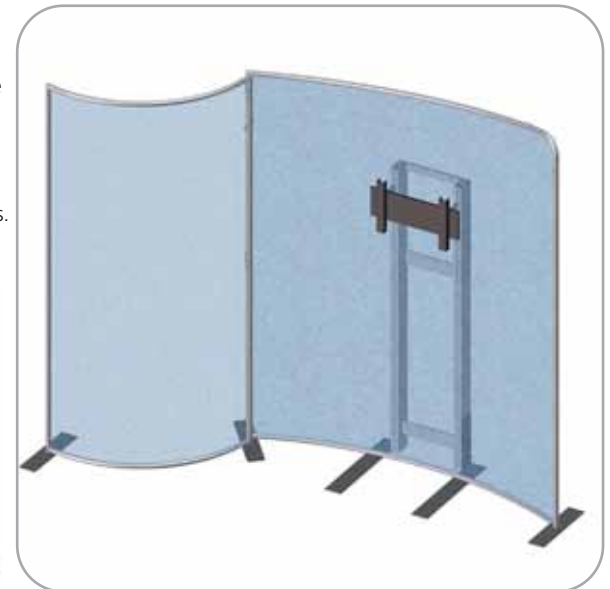

Your FIRST AND ONLY choice for trade show displays since 1994.

POP UP DISPLAYS



BANNER STANDS



TRADE SHOW DISPLAYS



AffordableDisplays.com

affordable
exhibit
displays inc

Partnering together to perfectly present your image.

