

Formulate Designer Series 20' Backwall - Kit 04

FMLT-DS-20-04

Formulate® Designer Series 20ft displays have unique stylistic features and shapes, are portable and easy to assemble. The aluminum tube frame features snap-buttons and / or spigot connections and zipper pillowcase fabric graphics. All displays come in portable, wheeled transit cases. Simply pull the pillowcase fabric graphic(s) over the frame and zip.



We are continually improving and modifying our product range and reserve the right to vary the specifications without prior notice. All dimensions and weights quoted are approximate and we accept no responsibility for variance. E&OE. See Graphic Templates for graphic bleed specifications.

features and benefits:

- Premium aluminum tube frames with snap button assembly
- Easy to store and ship
- Quick to set up
- Weighted feet for added stability
- Three zipper pillowcase fabric graphics
- Lifetime limited hardware warranty against manufacturer defects

dimensions:

Hardware

Assembled unit:
234.77" w x 96" h x 17.72" d
5963mm(w) x 2438mm(h) x 450mm(d)

Approximate weight with cases:
163 lbs / 73.9 kgs

Shipping

Packing case(s):
1 OCE
2 OCL

Shipping dimensions:
OCE: Expandable case length (l) may vary
40" - 66" l x 18" h x 18" d
1016mm-1677mm(l) x 458mm(h) x 458mm(d)

OCL:
56" l x 19" h x 19" d
1422mm(l) x 483mm(h) x 483mm(d)

Approximate shipping weight
(includes cases & graphics):

195 lbs / 88.4 kgs

Graphic

Refer to related graphic template for more information.

Visit:
www.exhibitors-handbook.com/graphic-templates

additional information:

Graphic material:
dye-sublimation zipper pillowcase fabric

affordable
exhibit
displays inc

Included In Your Kit

Tools, Components, & Connectors



HEX KEY SET x1



TC-30-90T x2



TC-30-90B x2



TC-30-T x2



TC-30-S x10



PLT-BP-LN114-S3-450 x2

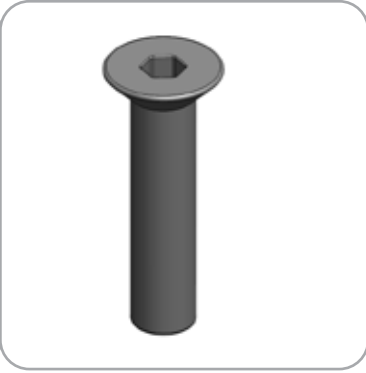

LN114-SCRW x7



PLT-BP-LN-114-S2-450 x3



TCP-3030 x2

Graphics

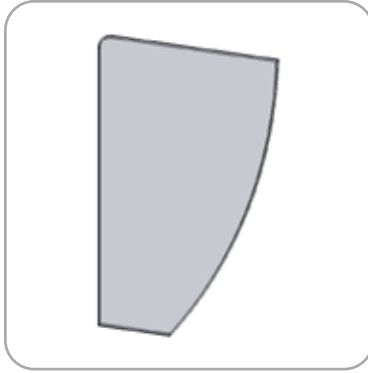

FMLT-DS-20-04-A-G x1

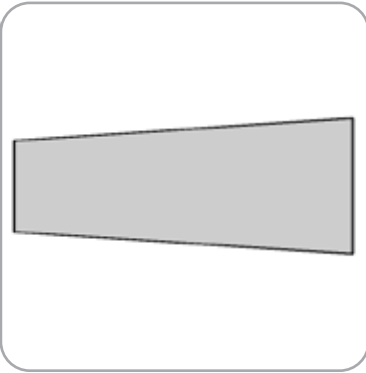

FMLT-DS-20-04-B-G x1



FMLT-DS-20-04-C-G x1

Included In Your Kit

Tubes



WS-01-T1 x1



WS10-T1 x8



WS10-T2 x12



WS10-T4 x2



WS10-T5 x2



WS10-T6 x2



WS10-T7 x2



WV20-01-T1 x1

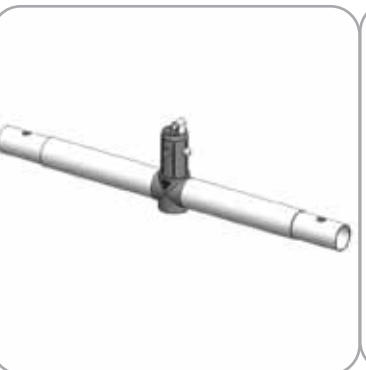

WS10-T4-B x1



DS-20-04-T1 x2



DS-20-04-T2 x4



DS-20-04-T3 x2



DS-20-04-T4 x2



DS-20-04-T5 x2



DS-20-04-T6 x2

Included In Your Kit

Tubes



DS-20-04-T7 x2

Exploded View

FMLT-DS-20-04

FRAME A

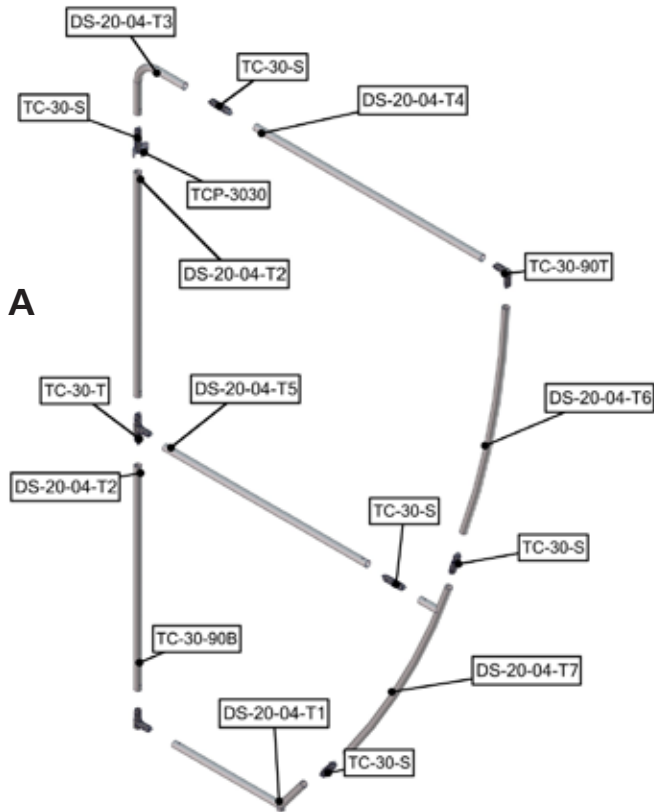

FRAME C

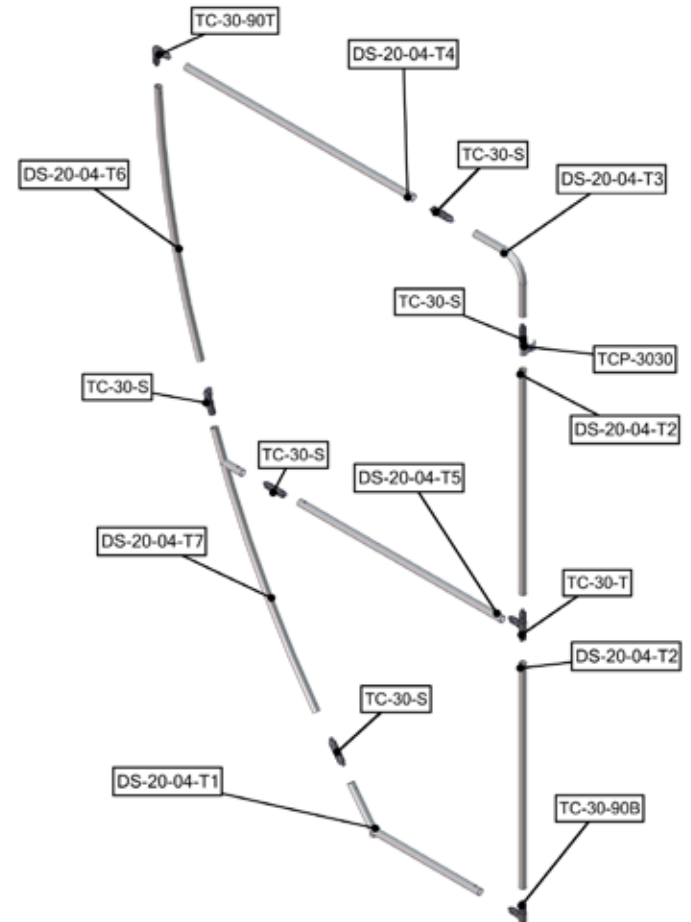

Exploded View

FMLT-DS-20-04

FRAME B

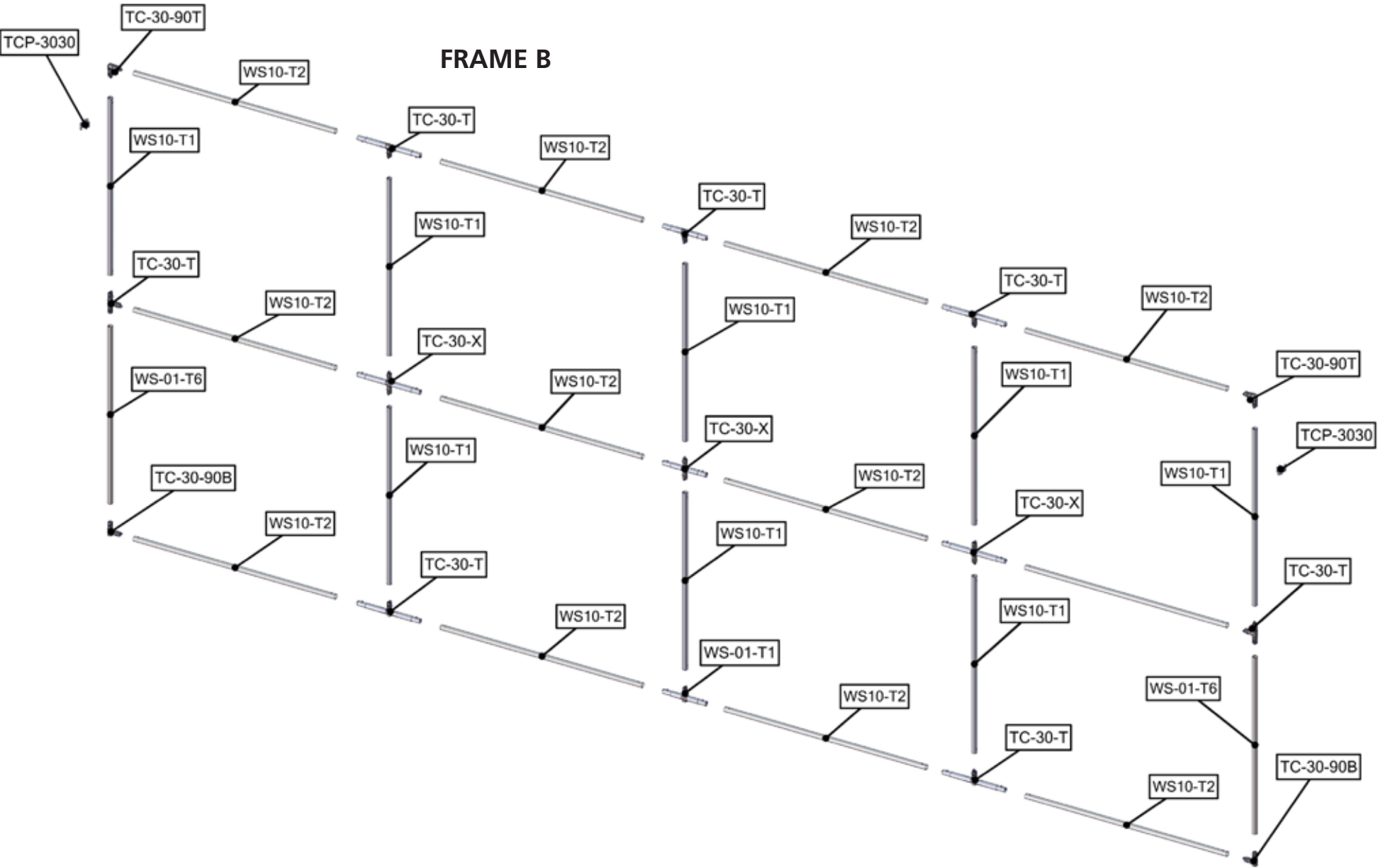

Labeling Diagram

FMLT-DS-20-04

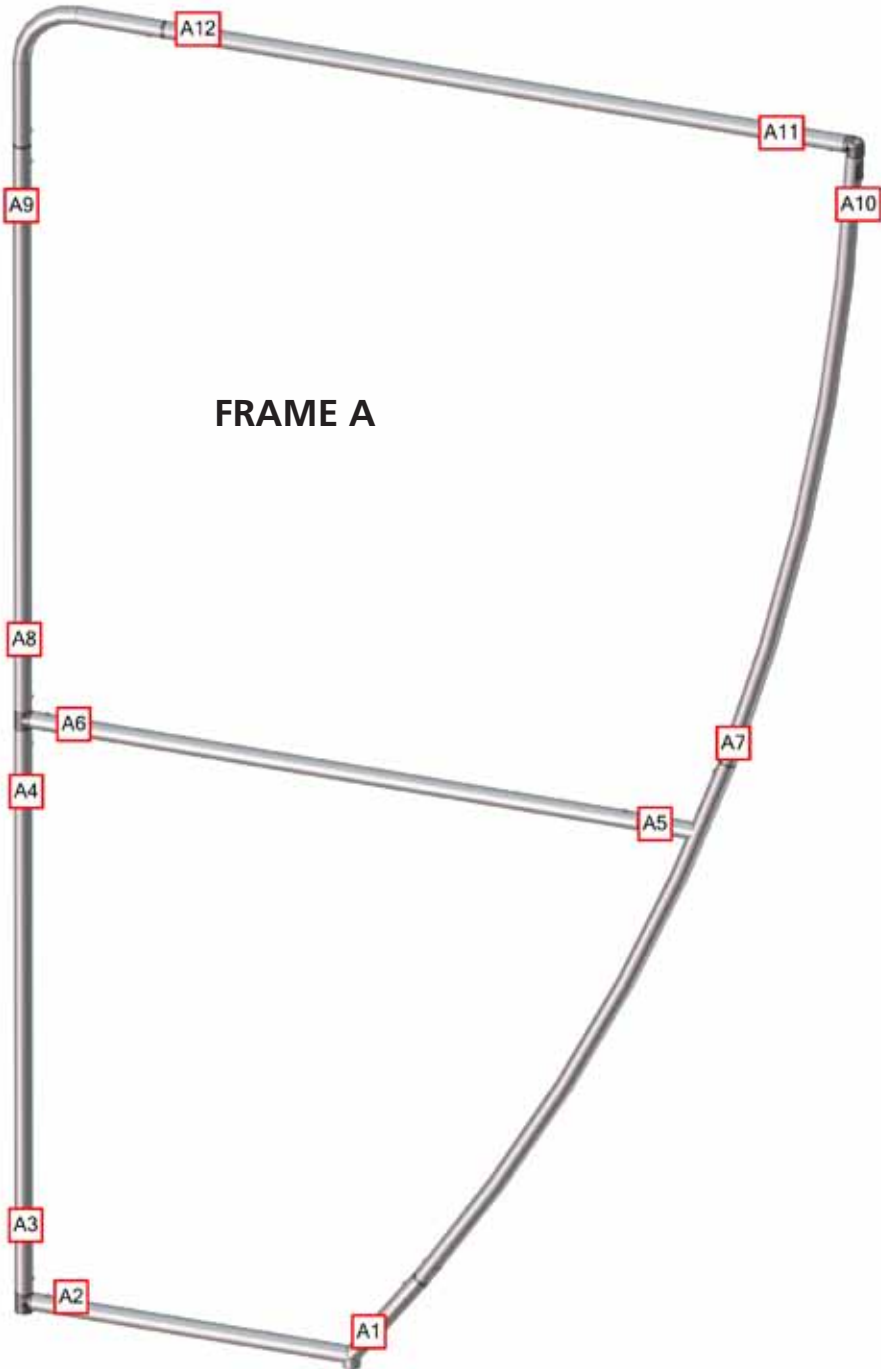

Labeling Diagram

FMLT-DS-20-04

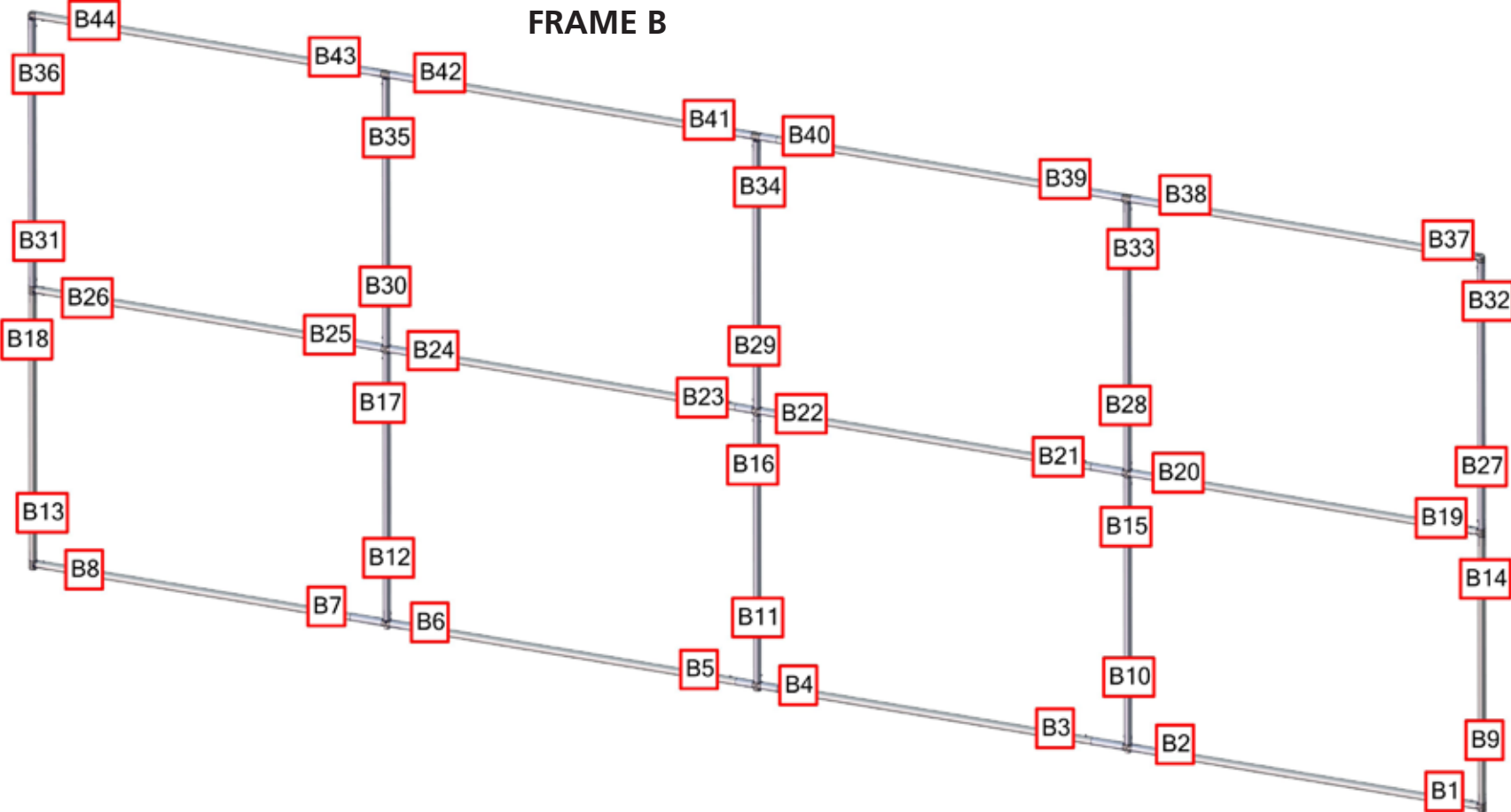

Labeling Diagram

FMLT-DS-20-04

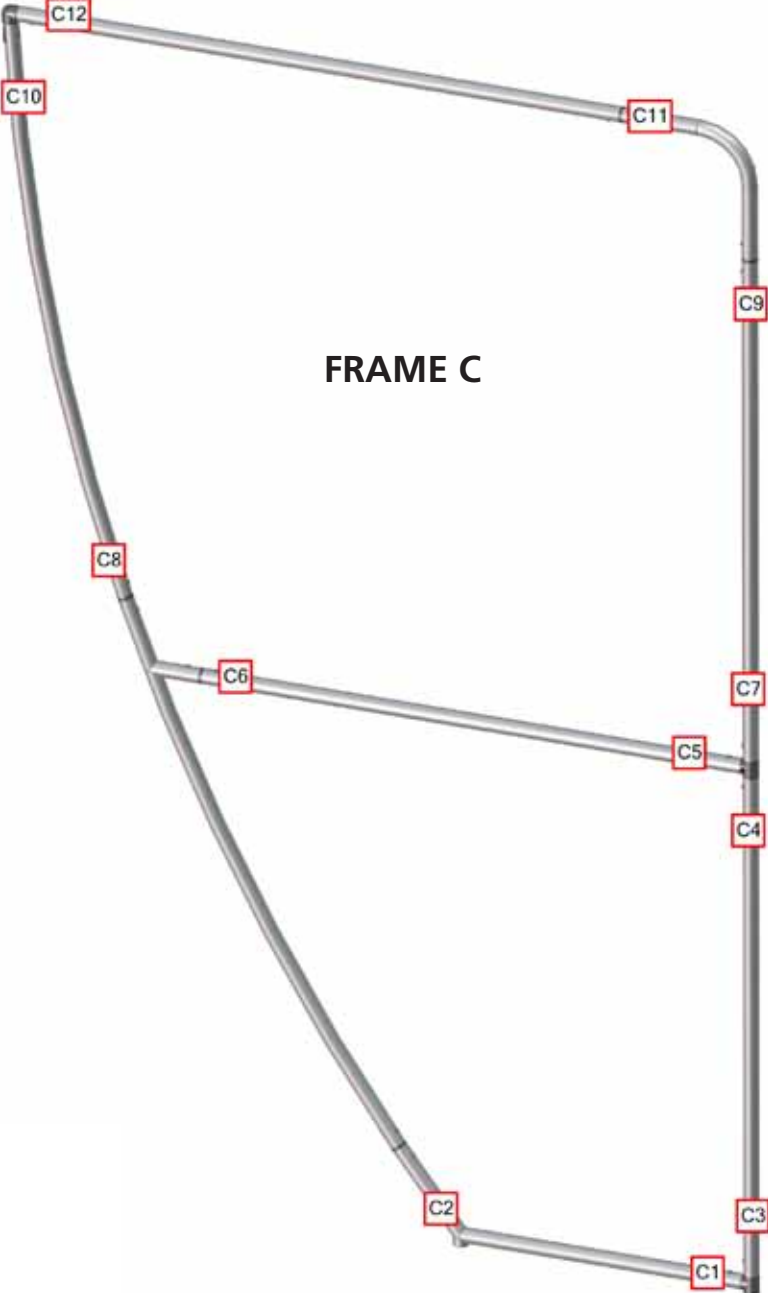

FRAME C

Connection Methods

Formulate™ structures use a number of different yet simple connection methods. Your kit will include one or more of the connection methods shown below. Steps within the Kit Assembly will reference a specific method for each connection point.

Connection Method 1: ES30 / ES50 / ES75

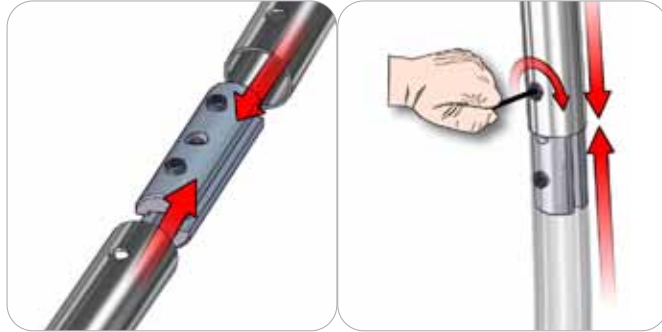

Compress the unlocked connector and slide one tube onto each end. Lock both screws carefully using your hex key tool. Be sure to lock securely, but do not overtighten.

Connection Method 2: Snap Buttons & Swage

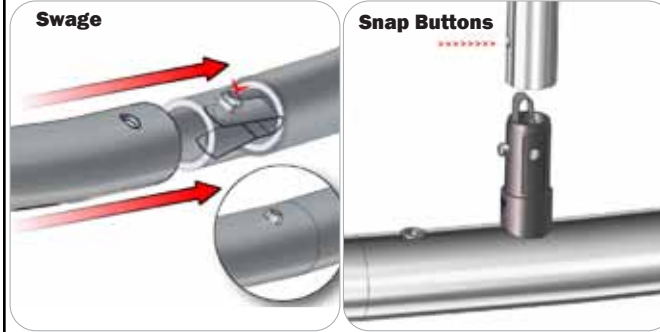

Locate the snap button on the connector or swage tube. Locate the hole on the corresponding tube. Press the snap button with your thumb and slide the tube and connector together so that the snap button snaps fully into the lock hole. To disassemble, press the snap button and pull apart.

Connection Method 3: ES30-90B / ES30-I / ES30-C



Compress one unlocked end of the connector and slide it through one tube end. Compress the other end of the connector and slide the second tube on. Lock both screws carefully using your hex key tool. Be sure to lock securely, but do not overtighten.

Connection Method 4: Tube Clamps



Be sure to fully assemble all frames before using clamps. With the clamp unlocked, place one tube of the first frame into the mouth of the clamp. Place the second tube (if applicable) into the second mouth of the clamp. With both frame's tubes in the clamp, be sure to lock securely, but do not overtighten.

Kit Assembly

Step by Step:

Step 1.

Locate the components necessary for assembling Frame A. Assemble your frame in order according to the Labeling Diagram.

Please reference Connection Method 2 for more details.

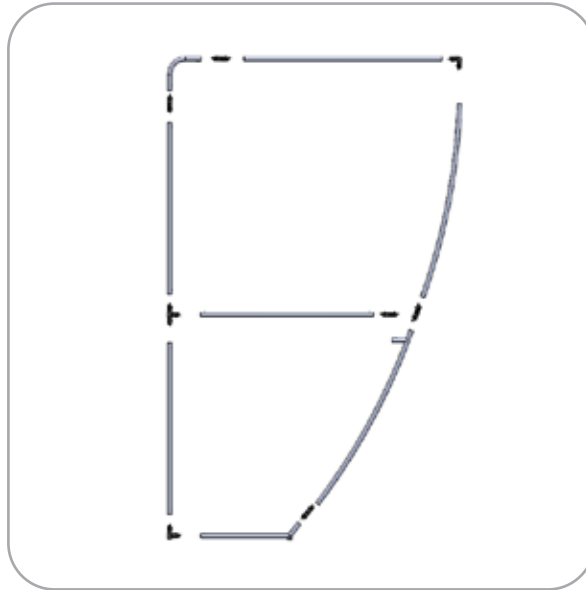

Step 2.

Locate the components necessary for assembling Frame C. Assemble your frame in order according to the Labeling Diagram.

Please reference Connection Method 2 for more details.

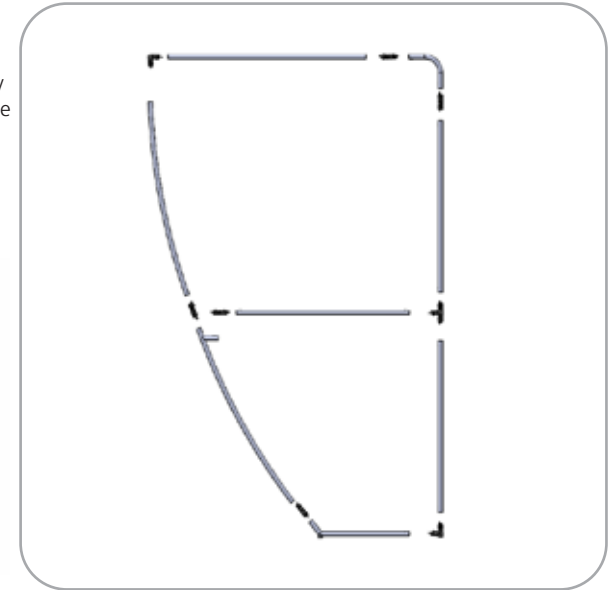

Step 3.

Locate the components necessary for assembling Frame B. Assemble your frame in order according to the Labeling Diagram.

Please reference Connection Method 2 for more details.

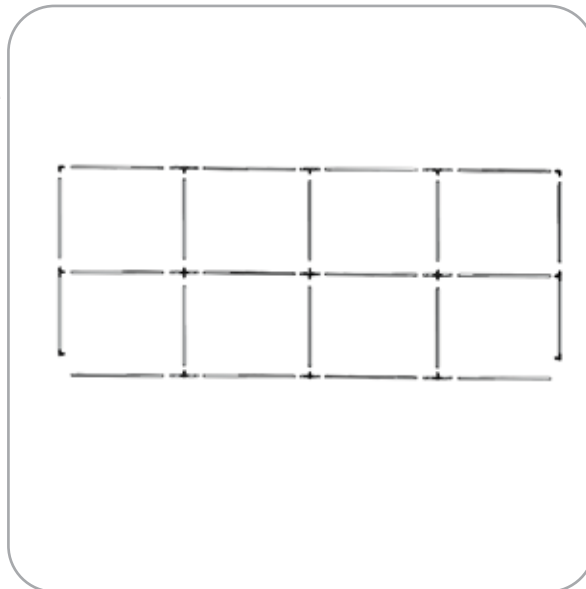
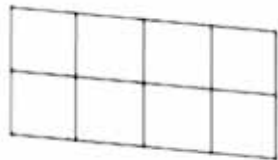

Step 4.

Fit graphic A onto Frame A. For ease of installation, pull the fabric cover up from the bottom of frame while the frame rests flat on the floor. Zip to enclose.

Zipper Located on the Top of Graphic A.

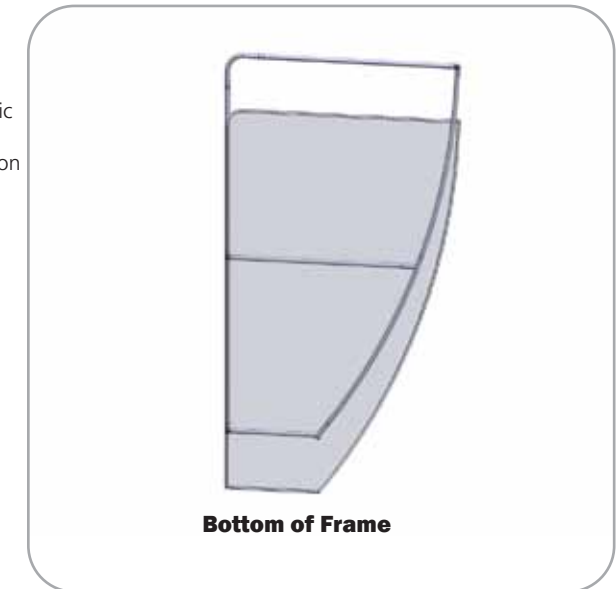

Kit Assembly

Step by Step:

Step 5.

Fit graphic C onto Frame C. For ease of installation, pull the fabric cover up from the bottom of frame while the frame rests flat on the floor. Zip to enclose.

Zipper Located on the Top of Graphic C.

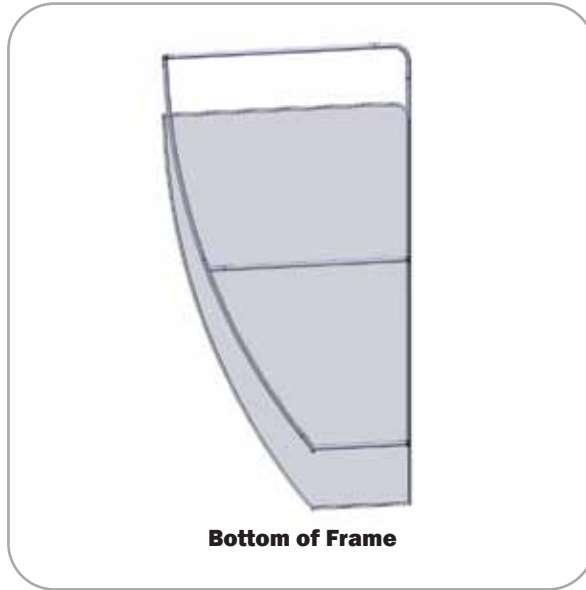
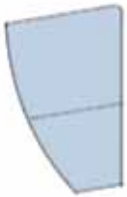

Step 6.

Fit graphic B onto Frame B. For ease of installation, pull the fabric cover over the top of the frame while the frame rests flat on the floor. Zip to enclose.

Zipper Located on the Bottom of Graphic C.

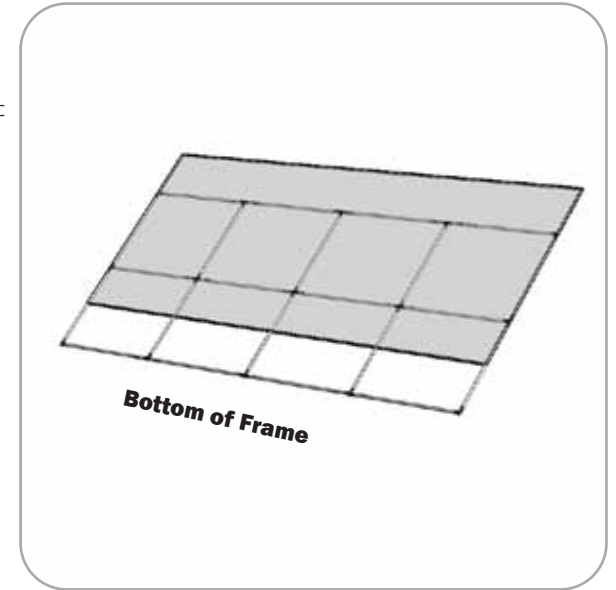

Step 7.

To attach Frame A and C to Frame B, gather two PLT-BP-LN114-S3, and two LN114 screws. Attach the foot to the left side of Frames A and B and the foot to the right sides of Frames B and C.

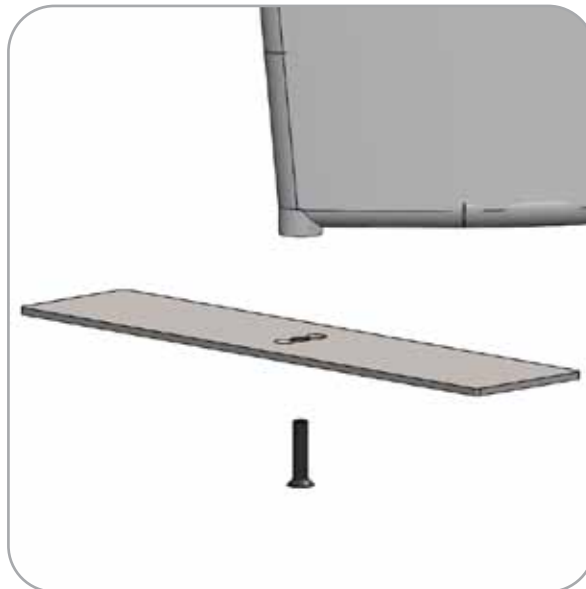

Step 8.

Locate your PLT-BP-LN114-S3-450, one LN114 screw. Attach the foot to the foot to the center of Frame B.



Kit Assembly

Step by Step

Step 9.

Use your provided hex key tool to connect the frames together using the TCP-3030's.

Please reference Connection Method 4 for more details.

Setup Complete.



Your FIRST AND ONLY choice for trade show displays since 1994.

POP UP DISPLAYS



BANNER STANDS



TRADE SHOW DISPLAYS



AffordableDisplays.com

affordable
exhibit
displays inc

Partnering together to perfectly present your image.